

MHI

Manual No. '06 • SRK -T-058

TECHNICAL MANUAL
Collection data

WALL MOUNTED TYPE ROOM AIR-CONDITIONER

(Split system, air to air heat pump type)

SRK28HJ

SRK40HJ

 **MITSUBISHI HEAVY INDUSTRIES, LTD.**



Большая библиотека технической документации

<https://splitsystema48.ru/instrukcii-po-ekspluatacii-kondicionerov.html>

каталоги, инструкции, сервисные мануалы, схемы.

CONTENTS

1 GENERAL INFORMATION	1
1.1 Specific features	1
1.2 How to read the model name	1
2 SELECTION DATA	2
2.1 Specifications	2
2.2 Range of usage & limitations	4
2.3 Exterior dimensions	4
2.4 Piping system	6
2.5 Selection chart	7
3 ELECTRICAL DATA.....	8
3.1 Electrical wiring	8
4 OUTLINE OF OPERATION CONTROL BY MICROCOMPUTER	10
5 APPLICATION DATA	20
5.1 Selection of location for installation	21
5.2 Installation of indoor unit	22
5.3 Installation of outdoor unit	24
5.4 Refrigerant piping.....	24
5.5 Test run	26
5.6 Precautions for wireless remote controller installation and operation	26
6 MAINTENANCE DATA	27
6.1 Trouble shooting	27
6.2 Servicing.....	31
6.3 Power supply remote operation	32

1 GENERAL INFORMATION

1.1 Specific features

The "MITSUBISHI HEAVY INDUSTRIES, LTD" room air conditioner: SRK series are of split and wall mounted type and the unit consists of indoor unit and outdoor unit with refrigerant precharged in factory. The indoor unit is composed of room air cooling or heating equipment with operation control switch and the outdoor unit is composed of condensing unit with compressor.

(1) Remote control flap

The flap can be automatically controlled by operating wireless remote control.

- AUTO (Natural flow) : Flap operation is automatically control.
- Swing : This will swing the flap up and down.
- Memory flap : Once the flap position is set, the unit memorizes the position and continues to operate at the same position from the next time.

(2) Automatic Operation

When the remote control switch is set on "auto", it will either automatically decide operation mode such as cooling, heating and thermal dry, or operate in the operation mode before it has been turned to automatic control.

(3) Self diagnosis Function

We are constantly trying to do better service to our customers by installing such judges that show abnormality of operation as follows.

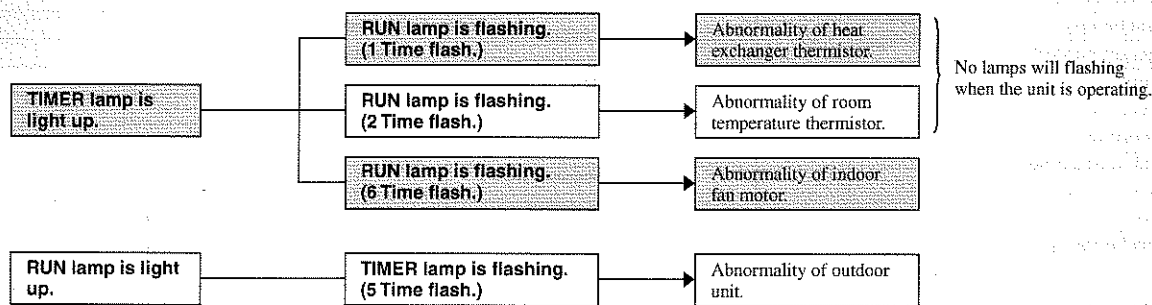

1.2 How to read the model name

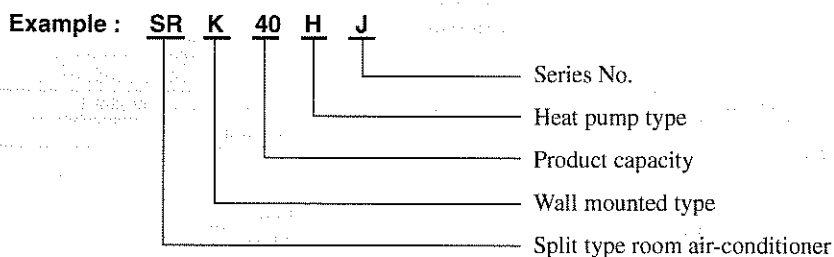

2 SELECTION DATA

2.1 Specifications

Model SRK28HJ (Indoor unit)
SRC28HJ (Outdoor unit)

Item		Model	SRK28HJ	SRC28HJ
Cooling capacity ⁽¹⁾		W	2500	
Heating capacity ⁽¹⁾		W	2900	
Power source			1 Phase, 220/230V, 50Hz	
Operation data ⁽²⁾	Cooling input	kW	0.94	
	Running current (Cooling)	A	4.3	
	Heating input	kW	0.88	
	Running current (Heating)	A	4.0	
	Inrush current	A	17.3	
	COP		cooling : 2.65 Heating : 3.30	
Noise level	Cooling	Sound level	41	49
		Power level	55	63
	Heating	Sound level	41	49
		Power level	55	63
Exterior dimensions Height x Width x Depth		mm	275 x 790 x 190	542 x 790 x 250
Color			Ivory white	Polar white
Net weight		kg	9	31
Refrigerant equipment Compressor type & Q'ty			-	2P17C225ANB (Rotary type) x 1
Motor		kW	-	0.75
Starting method			-	Line starting
Heat exchanger			Louver fins & inner grooved tubing	
Refrigerant control			Capillary tubes	
Refrigerant ⁽³⁾		kg	R22 0.76 (Pre-Charged up to the piping length of 5m)	
Refrigerant oil		ℓ	0.35 (SUNISO 4GDID)	
Defrost control			MC control	
Air handling equipment Fan type & Q'ty			Tangential fan x 1	Propeller fan x 1
Motor		W	18	18
Air flow (at High)	(Cooling)	CMM	7.5	28
	(Heating)		8.5	28
Air filter, Q'ty			Polypropylene net (washable) x 2	
Shock & vibration absorber			-	Cushion rubber (for compressor)
Electric heater			-	-
Operation control Operation switch			Wireless-Remote controller	
Room temperature control			MC. Thermostat	
Pilot lamp			RUN(Green), TIMER(Yellow), HI POWER(Orange), ECONOMY(Green)	
Safety equipment			-	Dome mounted protector (for compressor) Internal thermostat (for fan motor)
Refrigerant piping	O.D	mm(in)	Liquid line: ø6.35 (1/4") Gas line: ø9.52 (3/8")	
	Connecting method		Flare connecting	
	Attached length of piping		Liquid line: 0.4m Gas line : 0.35m	-
	Insulation		Necessary (Both sides)	
Drain hose			Connectable	
Power source cord			2.5m (3 cores with Earth)	
Connection wiring	Size x Core number		1.5mm ² x 5 cores (Including earth cable)	
	Connecting method		Terminal block (Screw fixing type)	
Accessories (included)			Mounting kit	
Optional parts			-	

Notes (1) The data are measured at the following conditions.

Item	Indoor air temperature		Outdoor air temperature		Standards
	DB	WB	DB	WB	
Cooling	27°C	19°C	35°C	24°C	ISO-T1, JIS C9612
Heating	20°C	-	7°C	6°C	ISO-T1, JIS C9612

(2) The operation data are applied to the 220V or 230V districts respectively

(3) The refrigerant quantity to be charged includes the refrigerant in 5m connecting piping.

(Purging is not required even in the short piping.)

If the piping length is longer, it is 5 to 15m, add 30g refrigerant per meter.

Model SRK40HJ (Indoor unit)
SRC40HJ (Outdoor unit)

Item		Model	SRK40HJ	SRC40HJ
Cooling capacity ⁽¹⁾		W	3600	
Heating capacity ⁽¹⁾		W	4200	
Power source			1 Phase, 220/230V, 50Hz	
Operation data ⁽¹⁾	Cooling input	kW	1.39	
	Running current (Cooling)	A	6.6	
	Heating input	kW	1.35	
	Running current (Heating)	A	6.4	
	Inrush current	A	35.0	
	COP		cooling : 2.59 Heating : 3.11	
Noise level	Cooling	Sound level	42	50
		Power level	56	64
	Heating	Sound level	42	50
		Power level	56	64
Exterior dimensions Height x Width x Depth		mm	275 x 790 x 190	542 x 790 x 250
Color			Ivory white	Polar white
Net weight		kg	9.5	37
Refrigerant equipment Compressor type & Q'ty			-	RH231VXAC (Rotary type) x 1
Motor		kW	-	1.1
Starting method			-	Line starting
Heat exchanger			Louver fins & bare tubing	
Refrigerant control			Capillary tubes	
Refrigerant ⁽²⁾		kg	R22 1.08 (Pre-Charged up to the piping length of 5m)	
Refrigerant oil		ℓ	0.52 (DIAMOND MS-56)	
Defrost control			MC control	
Air handling equipment Fan type & Q'ty			Tangential fan x 1	Propeller fan x 1
Motor		W	18	20
Air flow (at High)	(Cooling)	CMM	8.5	28
	(Heating)		9.0	28
Air filter, Q'ty			Polypropylene net (washable) x 2	
Shock & vibration absorber			-	Cushion rubber (for compressor)
Electric heater			-	-
Operation control Operation switch			Wireless-Remote controller	
Room temperature control			MC, Thermostat	
Pilot lamp			RUN(Green), TIMER(Yellow), HI POWER(Orange), ECONOMY(Green)	
Safety equipment			-	Dome mounted protector (for compressor) Internal thermostat (for fan motor)
Refrigerant piping	O.D	mm(in)	Liquid line: ø6.35 (1/4") Gas line: ø12.7 (1/2")	
	Connecting method		Flare connecting	
	Attached length of piping		Liquid line: 0.4m Gas line : 0.35m	
	Insulation		Necessary (Both sides)	
Drain hose			Connectable	
Power source cord			2.5m (3 cores with Earth)	
Connection wiring	Size x Core number		1.5mm ² x 5 cores (including earth cable)	
	Connecting method		Terminal block (Screw fixing type)	
Accessories (included)			Mounting kit	
Optional parts			-	

Notes (1) The data are measured at the following conditions.

Operation	Item	Indoor air temperature		Outdoor air temperature		Standards
		DB	WB	DB	WB	
Cooling		27°C	19°C	35°C	24°C	ISO-T1, JIS C9612
		20°C	-	7°C	6°C	
Heating						ISO-T1, JIS C9612

- (2) The operation data are applied to the 220V or 230V districts respectively
(3) The refrigerant quantity to be charged includes the refrigerant in 5m connecting piping.
(Purging is not required even in the short piping.)
If the piping length is longer, it is 5 to 15m, add 30g refrigerant per meter.

2.2 Range of usage & limitations

Model		All models
Item		
Indoor intake air temperature (Upper, lower limits)		Refer to the selection chart.
Outdoor air temperature (Upper, lower limits)		
Total one way piping length		Max. 15m
Difference in height between indoor and outdoor units	When above outdoor unit	Max. 5m
	When below outdoor unit	Max. 5m
Compressor stop/start frequency	1 cycle time	6 min or more (from stop to stop or from start to start)
	Stop time	3 min or more
Power source voltage	Voltage fluctuation	Within $\pm 10\%$ of rated voltage
	Voltage drop during start	Within $\pm 15\%$ of rated voltage
	Interval unbalance	Within $\pm 3\%$ of rated voltage

2.3 Exterior dimensions

(1) Indoor unit

Model SRK28HJ

Unit: mm

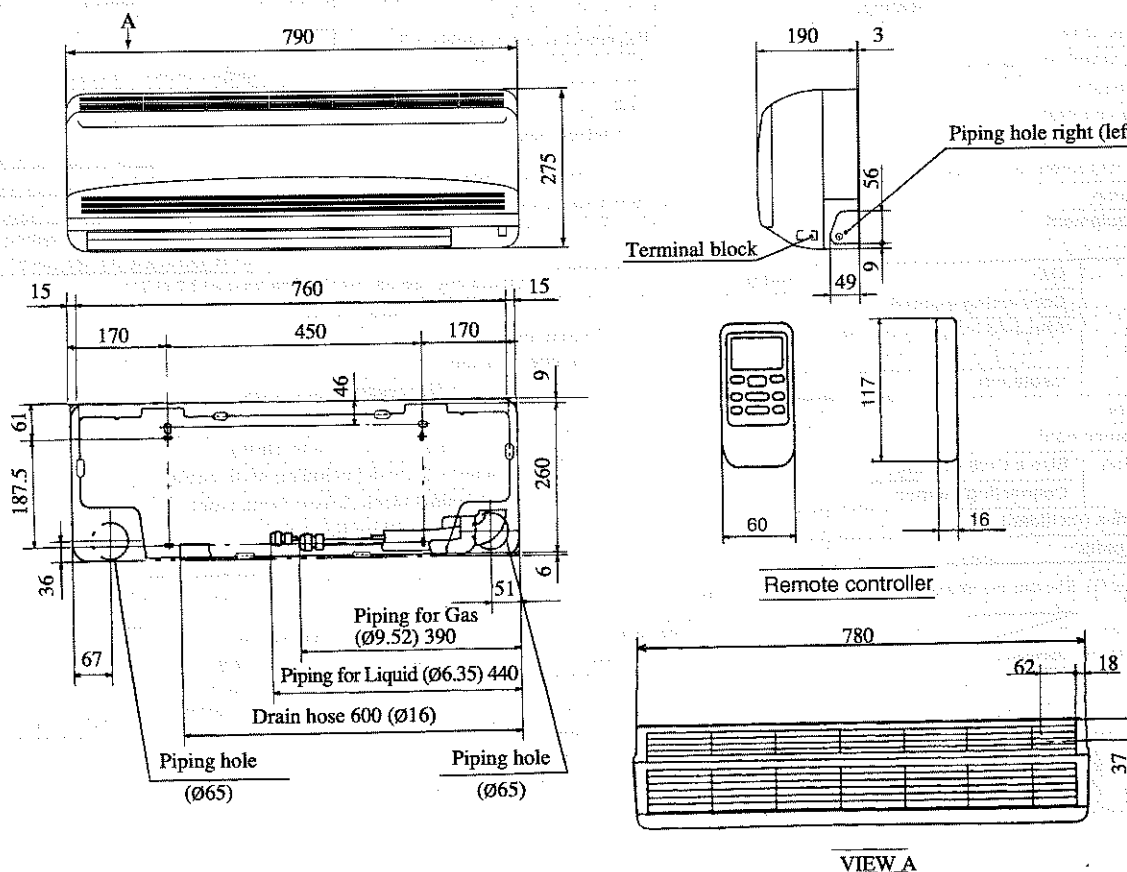

Model SRK40HJ

Unit: mm

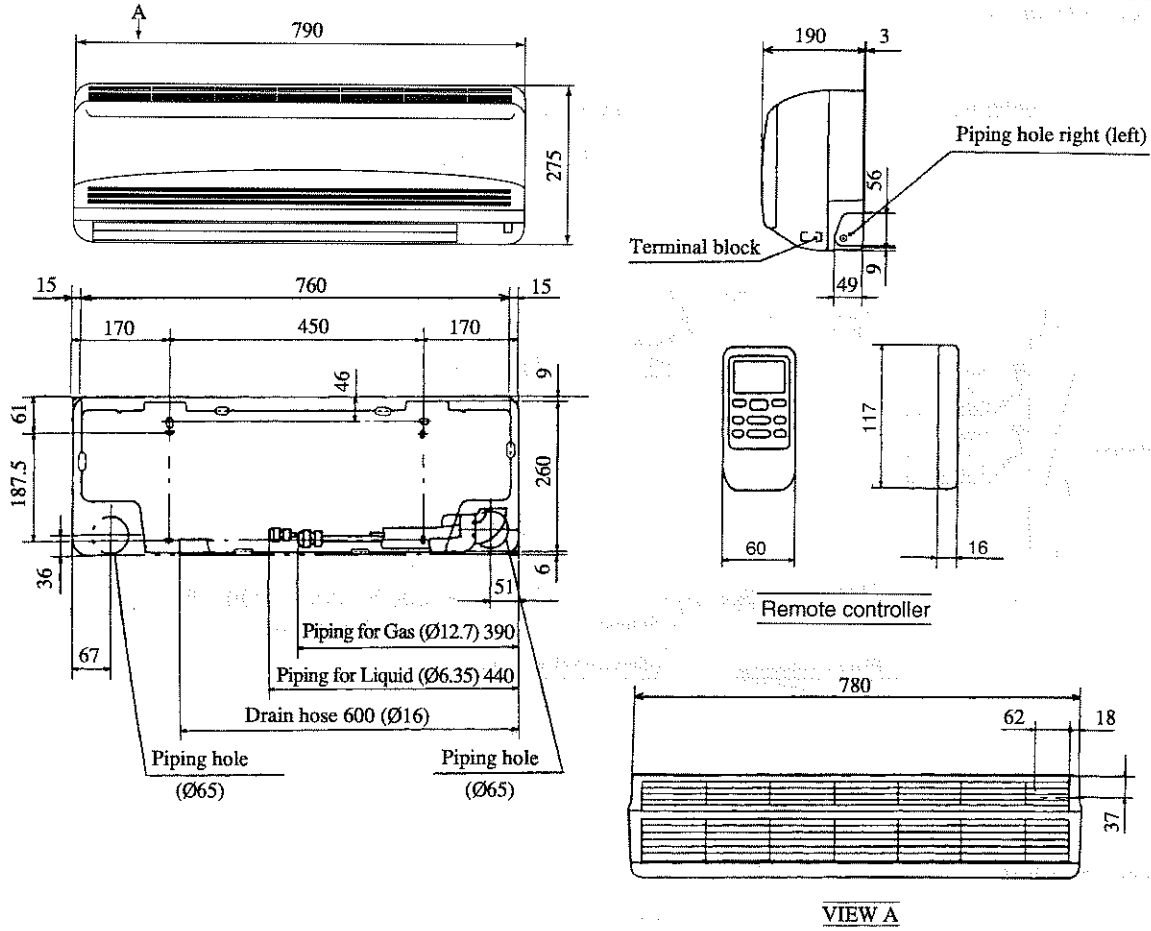

VIEW A

(2) Outdoor unit Models SRC28HJ, 40HJ

Unit: mm

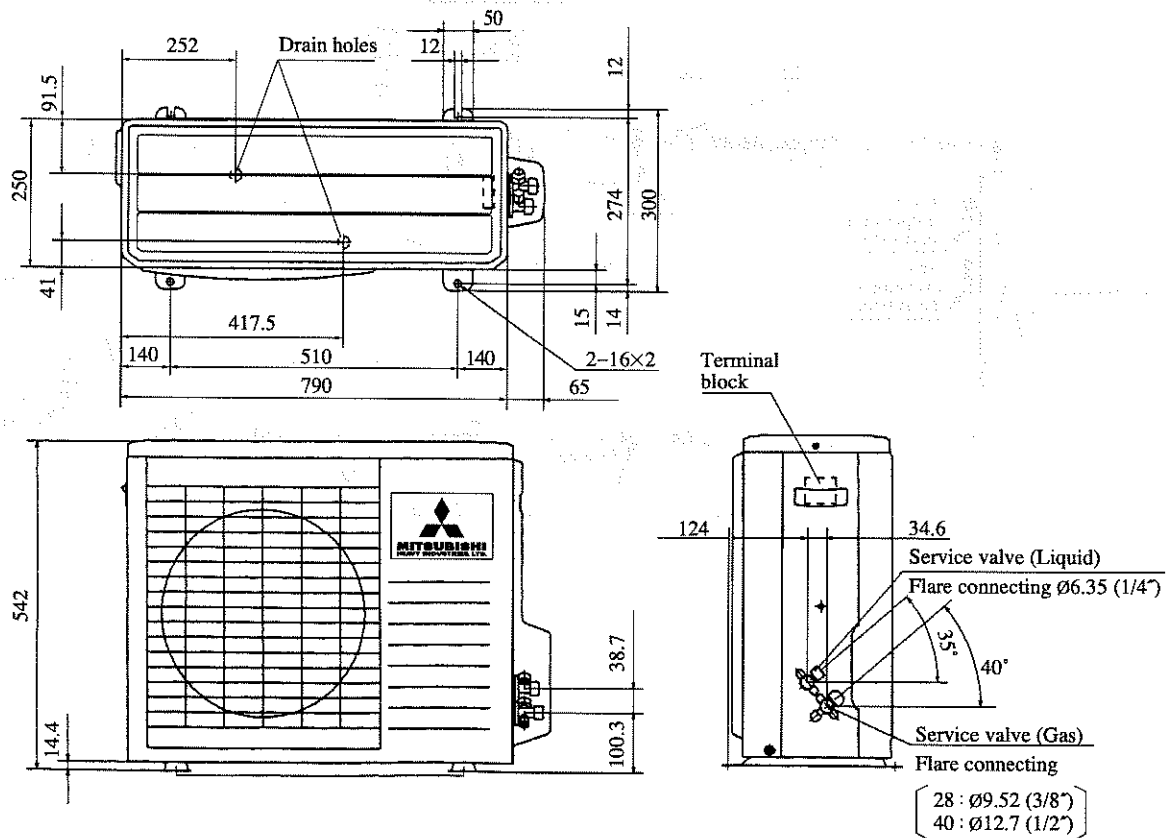

2.4 Piping system

Model SRK28HJ

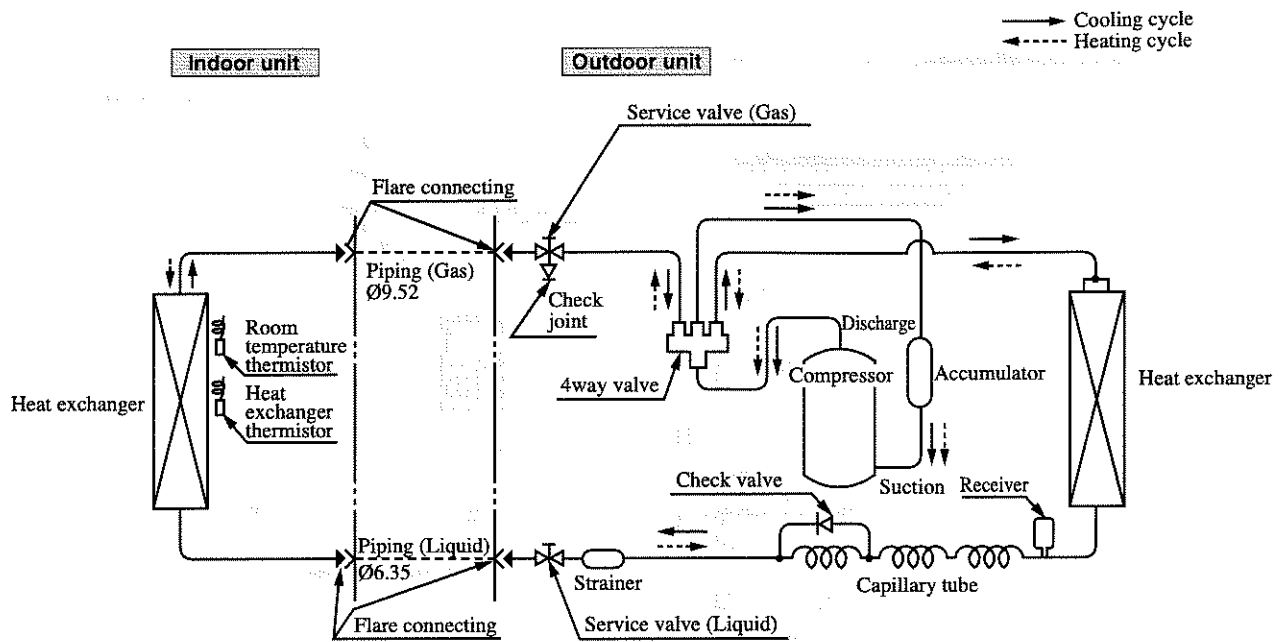

Model SRK40HJ

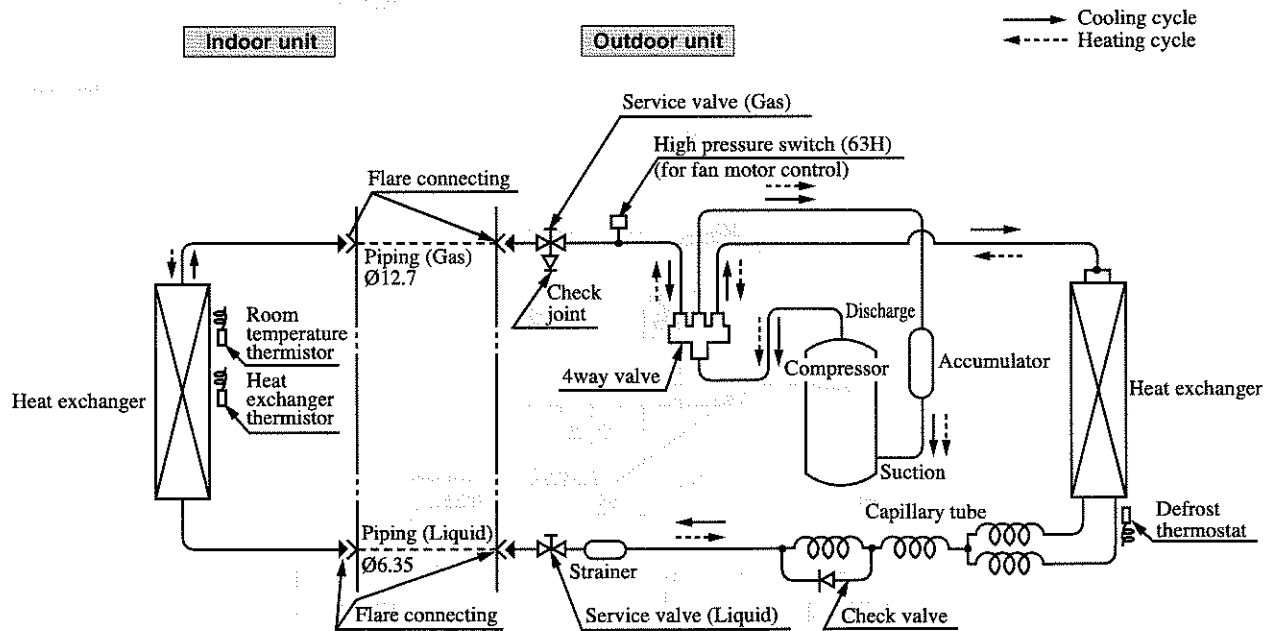

2.5 Selection chart

Correct the cooling and heating capacity in accordance with the conditions as follows. The net cooling and heating capacity can be obtained in the following way.

Net capacity = Capacity shown on specification × Correction factors as follows.

(1) Coefficient of cooling and heating capacity in relation to temperatures

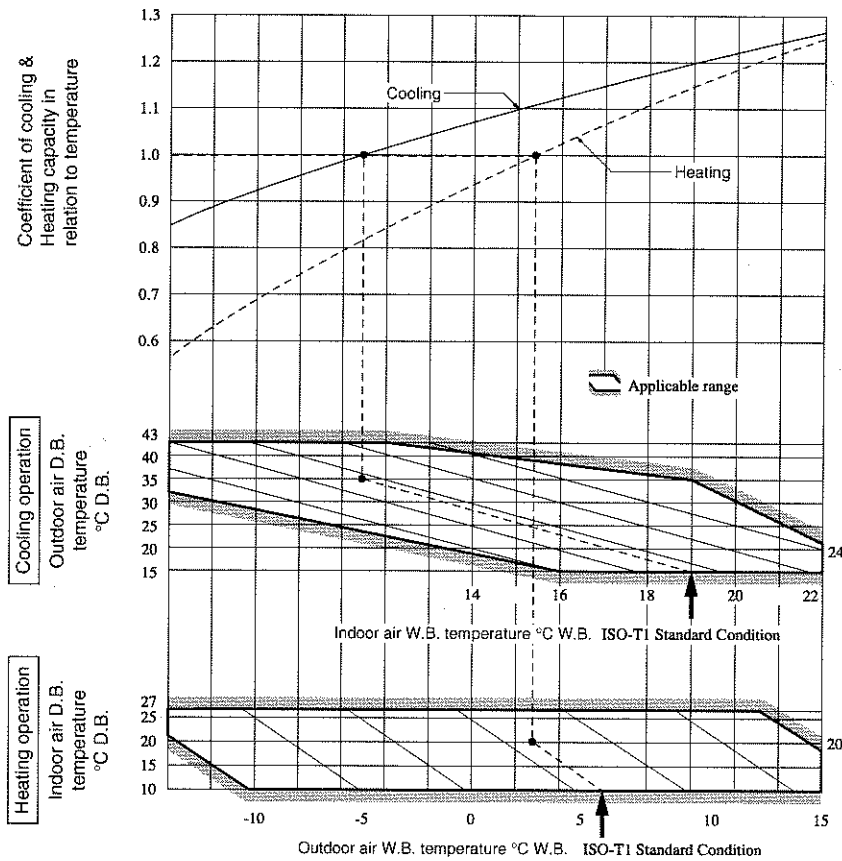

(2) Correction of cooling and heating capacity in relation to one way length of refrigerant piping

It is necessary to correct the cooling and heating capacity in relation to the one way piping length between the indoor and outdoor units.

Piping length [m]	7	10	15
Cooling	1.0	0.99	0.975
Heating	1.0	1.0	1.0

(3) Correction relative to frosting on outdoor heat exchanger during heating

In additions to the foregoing corrections (1), (2) the heating capacity needs to be adjusted also with respect to the frosting on the outdoor heat exchanger.

Air inlet temperature of outdoor unit in °CWB	-10	-9	-7	-5	-3	-1	1	3	5
Adjustment coefficient	0.95	0.94	0.93	0.91	0.88	0.86	0.87	0.92	1.00

3 ELECTRICAL DATA

3.1 Electrical wiring

Model SRK28HJ

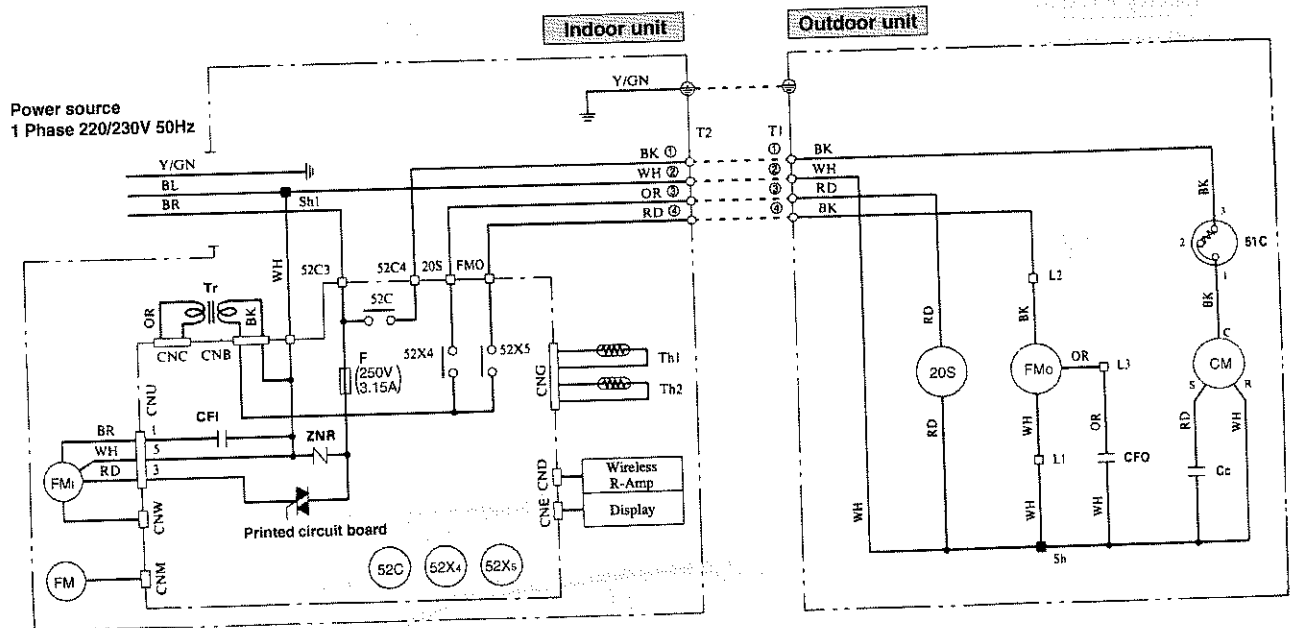

Color symbol

BK	Black
BL	Blue
BR	Brown
RD	Red
OR	Orange
WH	White
Y/GN	Yellow/Green

Meaning of marks

Symbol	Parts name	Symbol	Parts name
Cc	Capacitor for CM	Th1, 2	Thermistor
CFi	Capacitor for FMI	Tr	Transformer
CFo	Capacitor for FMO	ZNR	Varistor
CM	Compressor motor	20S	4 way valve, coil
F	Fuse	51C	Motor protector for CM
FMI	Fan motor (Indoor unit)	52C	Magnetic contactor for CM
FMO	Fan motor (Outdoor unit)	52X4, 5	Auxiliary relay
FM	Flap motor		

Table of relay operations

Relay symbol	Operation Control part	Operation		
		Cooling	Heating	Defrost
52X4	20S	×	○	×
52X5	FMO	○	○	×
52C	CM	○	○	○

Notes (1) ○ : denotes magnetized relay × : denotes demagnetized relay
 (2) Th1 is room temperature thermistor. Th2 (the heat exchanger thermistor) is the hot start, hot keep, and frost prevention thermistor. (for details, refer to pages 14, 15, 17)

Model SRK40HJ

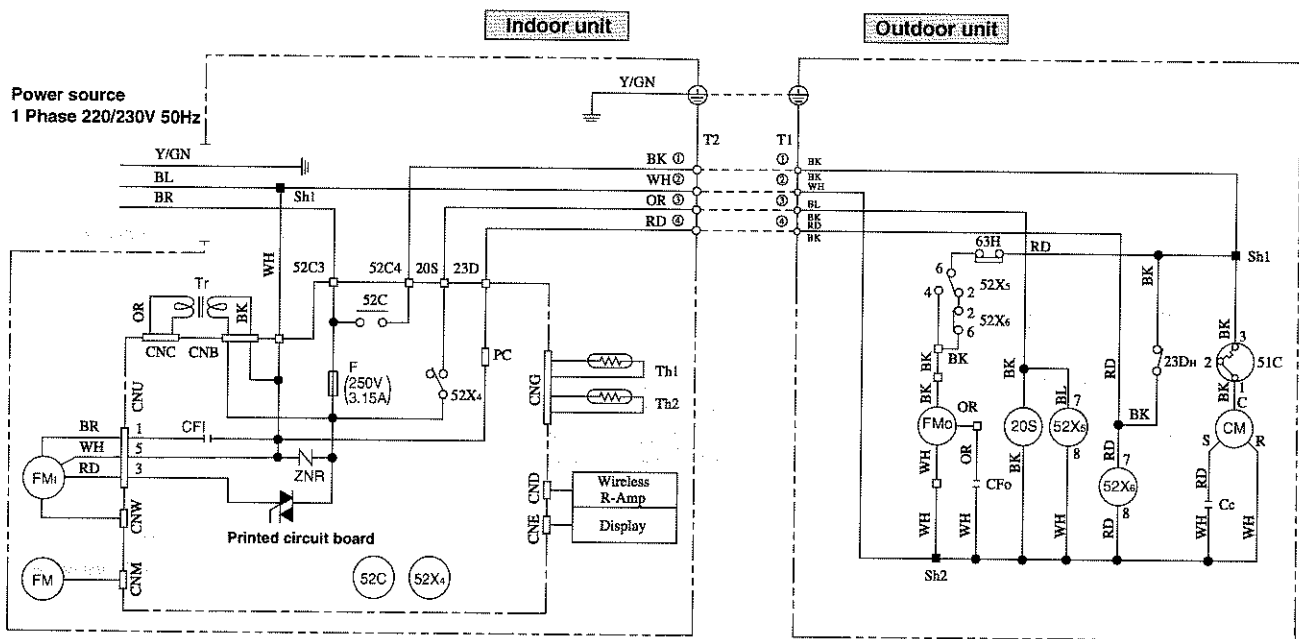

Color symbol

BK	Black
BL	Blue
BR	Brown
RD	Red
OR	Orange
WH	White
Y/GN	Yellow/Green

Meaning of marks

Symbol	Parts name	Symbol	Parts name
Cc	Capacitor for CM	Th1,2	Thermistor
CFi	Capacitor for FMi	Tr	Transformer
CFo	Capacitor for FMo	ZNR	Varistor
CM	Compressor motor	20S	4 way valve, coil
F	Fuse	51C	Motor protector for CM
FMi	Fan motor (Indoor unit)	52C	Magnetic conductor for CM
FMo	Fan motor (Outdoor unit)	52X4,5,6	Auxiliary relay
FM	Flap motor	63H	High pressure switch
PC	Photo coupler	23DH	Defrost thermostat

Table of relay operations

Relay symbol	Operation			
	Control part	Cooling	Heating	Defrost
52X4	20S	×	○	×
52X5	FMo	×	○	×
52X6		×	×	○
52C	CM	○	○	○

- Notes (1) ○ : denotes magnetized relay × : denotes demagnetized relay
 (2) Th1 is room temperature thermistor. Th2 (the heat exchanger thermistor) is the hot start, hot keep, and frost prevention thermistor. (for details, refer to pages 14,15,17)
 (3) Preset values:
 23DH (defroster stop thermostat): opens at over 14°C
 63H (overload protection high pressure switch during heating): closes at 2.02 / opens at 2.41 (MPa)

4 OUTLINE OF OPERATION CONTROL BY MICROCOMPUTER

(1) Remote controller

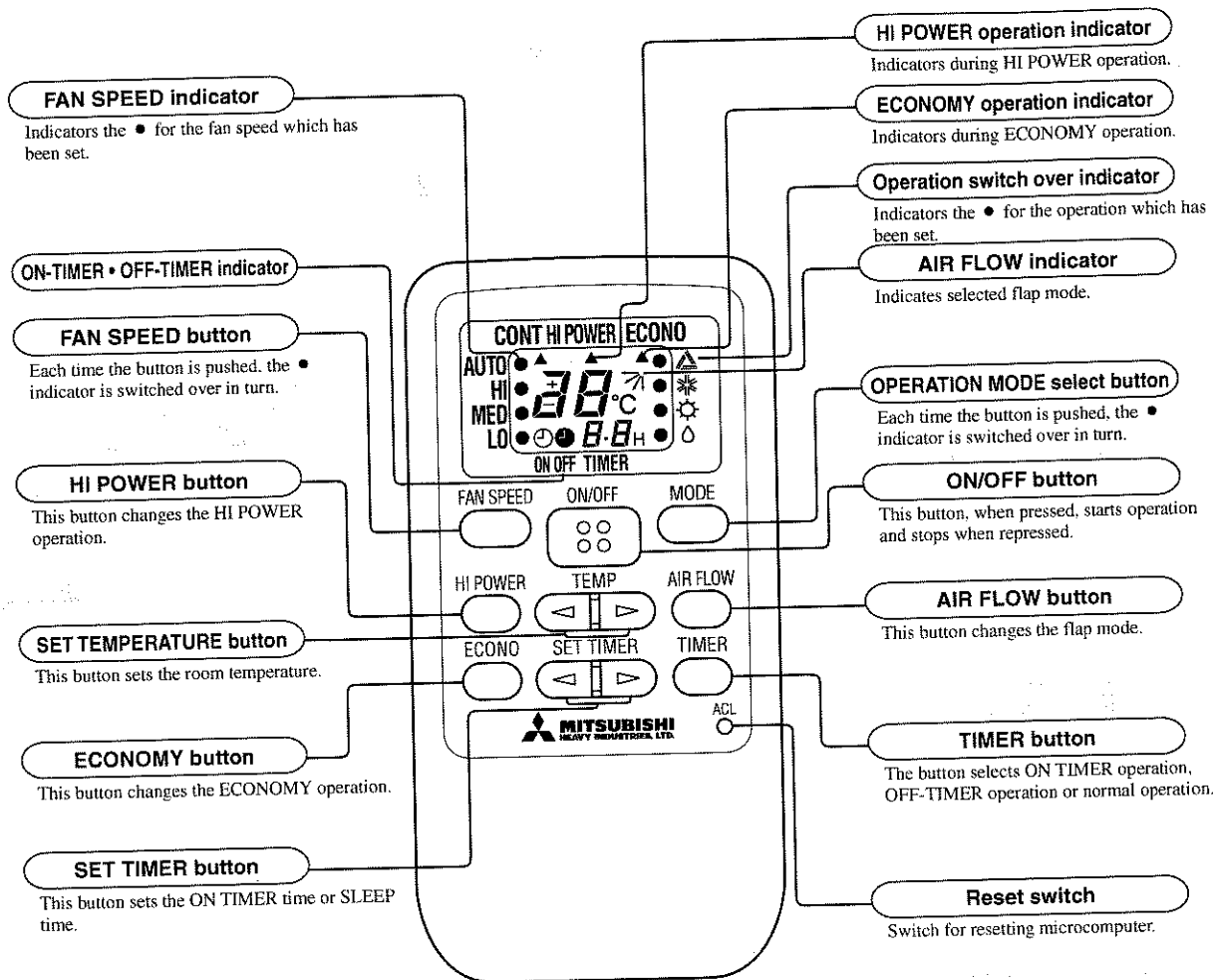

- Above figure shows all indications for the purpose of explanation, but practically only the pertinent parts are indicated.

Indoor unit indicator

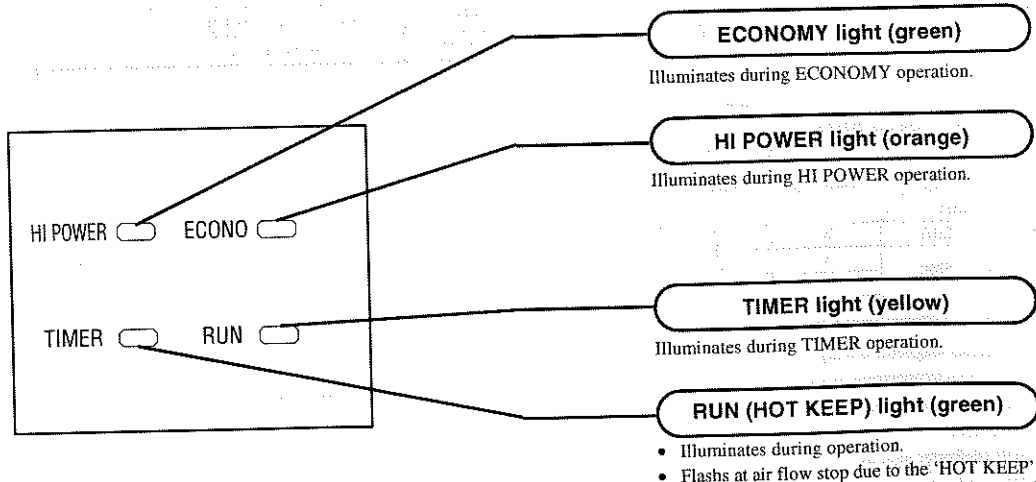

(2) Flap control

Control the flap by the AIRFLOW button on the wireless remote control

(a) AUTO (Natural flow)

The flap will be automatically set to the angle of air flow best to operation mode

1) Starting time of operation

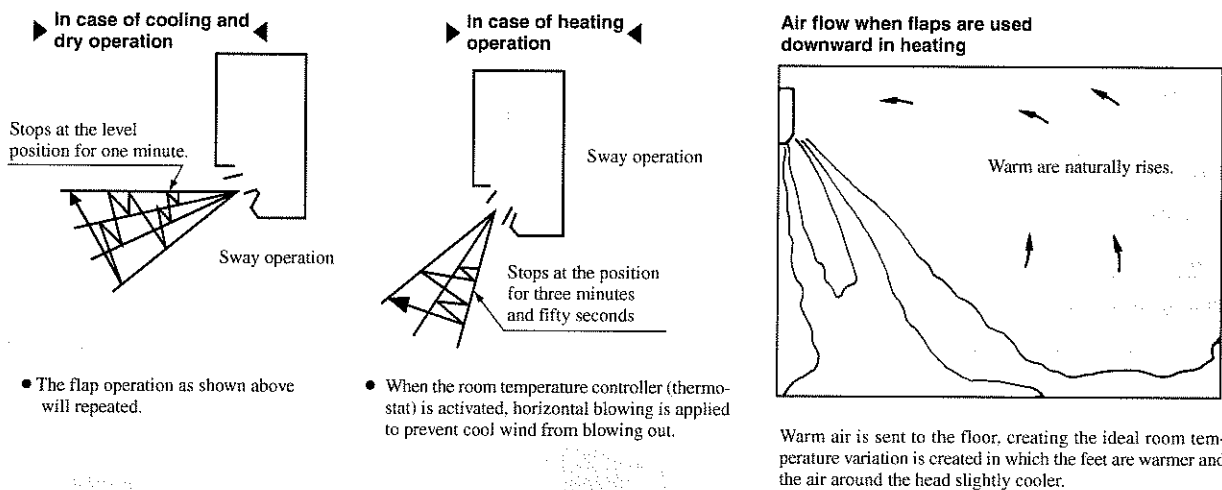

2) When not operating

The flap returns to the position of air flow directly below, when operation has stopped.

(b) Memory flap

While the flap is operating if the AIRFLOW button is pushed once, it stops swinging at an angle.

As this angle is memorized in the microcomputer, the flap will be automatically set to the angle when next operation is started.

- Recommendable stopping angle of the flap

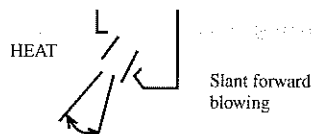

(c) Swing flap

Flap moves in upward and downward directions continuously.

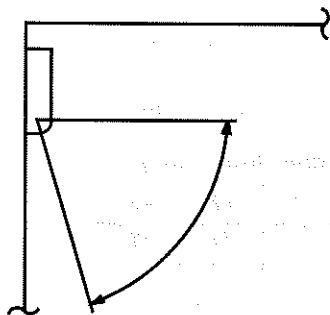

(3) Back-up Switch

When the remote controller batteries become weak, or if the remote controller is lost or malfunctioning, this switch may be used to turn the unit on and off.

(a) Operation

Push the switch once to place the unit in the automatic mode. Push it once more to turn the unit off.

(b) Details of operation

The unit will go into the automatic mode in which it automatically determines, from room temperature (as detected by thermistor), whether to go into the cooling, thermal dry or heating modes.

Function Operation mode	Room temperature setting	Fan speed	Flap	Timer switch
Cooling	About 26°C	Auto	Natural flow	Continuous
Thermal dry	About 25°C			
Heating	About 25°C			

On operating in automatic operation mode by back-up switch, functions show in the above table are not altered, while, the other micro-computer control functions remain effective.

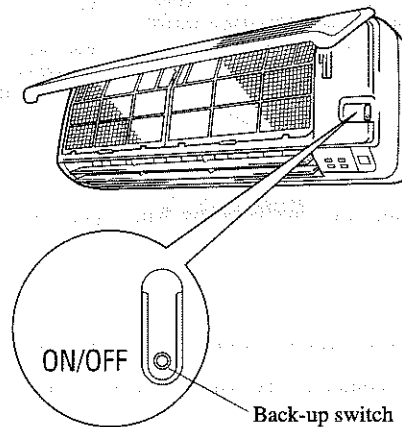

(4) AUTOMATIC operation

(a) When starting operation after more than 1 hour since operation stops

(Operation stop button ON or ON-Timer), this system operates indoor fan with Lo for 20 seconds checks room temperature and allowing decision of operating mode automatically.

	Room temperature < 21°C	21°C ≤ Room temperature < 26°C	26°C ≤ Room temperature
Operation Mode	Heating	Dry	Cooling

Note (1) Operating Mode is not altered due to change of room temperature.

When intended to change operating mode, switch operation change over dial to the intended mode.

(b) Established temperature (operate by the established temperature button on remote controller).

		Wireless remote control signal (Indication)												
		-6	-5	-4	-3	-2	-1	±0	+1	+2	+3	+4	+5	+6
Temperature setting	Cooling	20	21	22	23	24	25	26	27	28	29	30	31	32
	Thermal dry	19	20	21	22	23	24	25	26	27	28	29	30	31
	Heating	19	20	21	22	23	24	25	26	27	28	29	30	31

(c) When switching to automatic operation during "Heating" "Cooling" "Dry" or when restarting with in 1 hour after stopping with automatic operation mode, the former operating mode is selected. (In this case, 20 seconds Lo operation of indoor fan is not performed). When the previous mode is in "FAN", operation mode is to be set by the above mentioned chart.

(5) Comfort timer settings

Temperature is checked beginning 1 hour before the set time, and the power is turned on before the timer setting as necessary to bring the temperature to the proper level by the set time.

Operation mode	Room temperature thermistor (Th1)	Operating start time (amount of time previous to set time that operation begins)
Heating	Under 5°C	60 mins.
	Under 10°C	30 mins.
	Under 15°C	15 mins.
	Over 15°C	5 mins.
Cooling	Over 40°C	60 mins.
	Over 35°C	30 mins.
	Over 30°C	15 mins.
	Under 30°C	5 mins.

(6) Timer time setting

The turn-off timer and turn-on timer can be set for up to 12 hours in units of 1 hour.

(7) Night time turn off

Placing the timer to this setting changes the temperature setting of the indoor set button as follows:

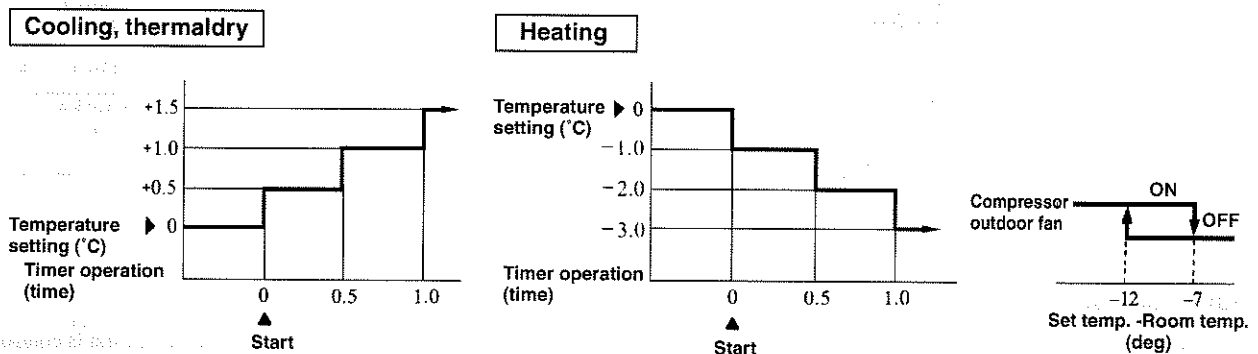

Note (1) The unit performs heating to the set time after 2.0 hours in the night time as shown right.

(8) Temperature adjustment

- a) Temperature adjustment setting may be set between 18 and 30°C.
- b) The compressor and outdoor fan and turned on and off as shown below according to the temperature setting.

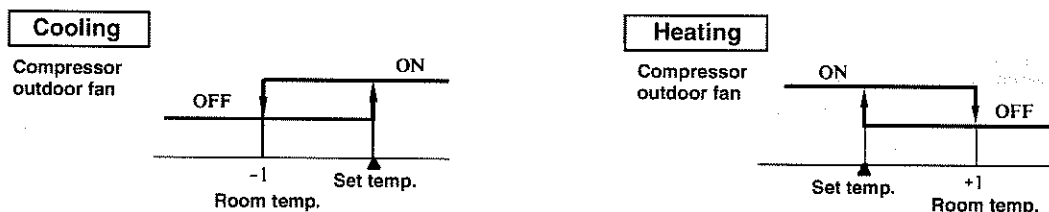

- c) During the continuous mode, the compressor runs continuously in both cooling and heating. For thermal dry, please refer to page 16.

(9) Fan control

(a) Fan speed change

Fan speed knob \ Mode	COOL	HEAT	FAN
AUTO	See below		
LOW	Speed 1 (Speed 1)	Speed 2 (Speed 2)	Speed 1 (Speed 1)
MED	Speed 2 (Speed 2)	Speed 3 (Speed 3)	Speed 2 (Speed 2)
HIGH	Speed 3 (Speed 4)	Speed 4 (Speed 5)	Speed 3 (Speed 3)

- Notes (1) Please refer to page 16 regarding dry operation.
 (2) Fan speeds shown in brackets are shown for when continuing with set temperatures.

(b) Fan speed knob: AUTO

- The indoor fan is automatically controlled in accordance with the difference between the room temperature (detected by the room temperature thermistor) and the thermostat setting as shown below.

Set-ting temp \ Mode	Heating	Cooling	Fan
18~30°C			
Continuous	Speed 5	Speed 4	Speed 3

- Note (1) Please refer to page 16 regarding dry operation.

(10) 3 Hot system

When initiating heating operation, restoring thermostat, defrosting operation, the indoor fan motor and the thermostat is controlled by micro computer in accordance with the room air temp, and temp. of the indoor heat exchanger.

- By this blowing of cold air is prevented and comfortable heating operation is assured.
- Controls of thermostat and indoor fan motor.

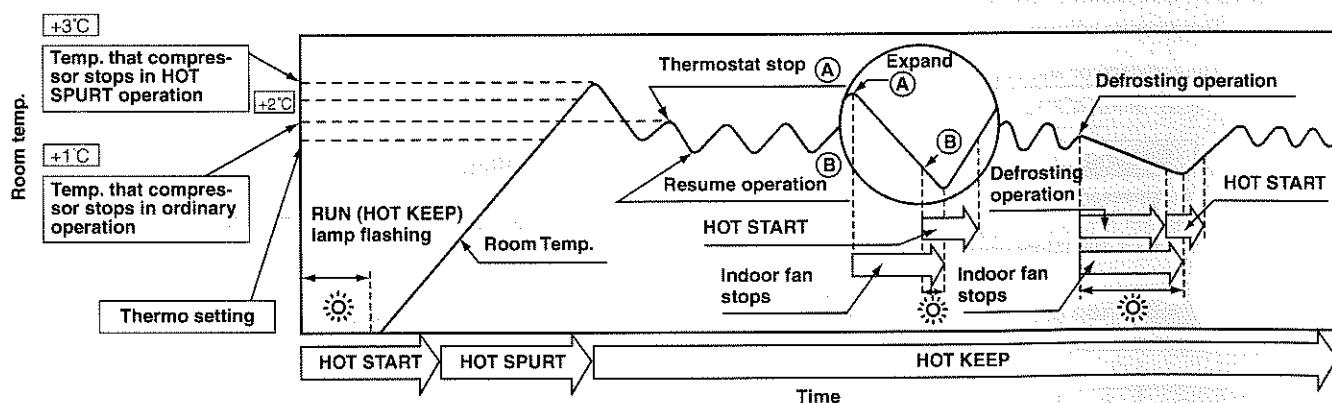

(a) HOT START (RUN (Hot keep) lamp flashing when the indoor fan is stopped)

1) Operation timing

- When the compressor is starting. (when starting operation and resuming operation by restored thermostat)
- When the defrosting operation is switched to the heating operation.

2) Function

- a) The indoor fan motor is controlled in accordance with the temperature of the indoor heat exchanger to send warm air from the start.
- b) When the air flow increases at heating starting as shown below, the temperature of the indoor heat exchanger become lower since the intake air temperature is still low. By this the fan speed is decreased. In this case, in order to prevent excessively ON/OFF switching of the fan motor, the controlling temperature is made different from the controlling temperature for HOT KEEP.

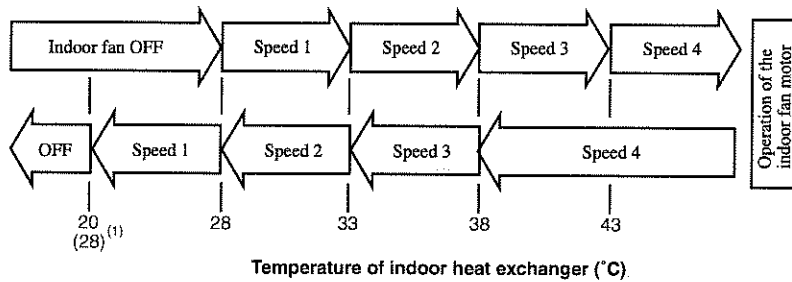

Note (1) When the compressor has stopped, the indoor fan will stop at 28°C.

(b) HOT SPURT

1) Operation timing

When starting operation. (during start-up)

2) Function

The set temperature of the thermostat is increased by 2°C to stabilize the room temperature quickly. When starting heating, since the surrounding wall and furniture is cold, if the compressor is stopped by thermostat, the 3 min. delay timer operates, the temperature drops rapidly during the 3 min, and although the thermostat has to resume operation, air conditioner would not start for those 3 min. (where marked *)

Restore the set temperature to the original value when the compressor is stopped once by the thermostat or 40 minutes have elapsed since the operation start.

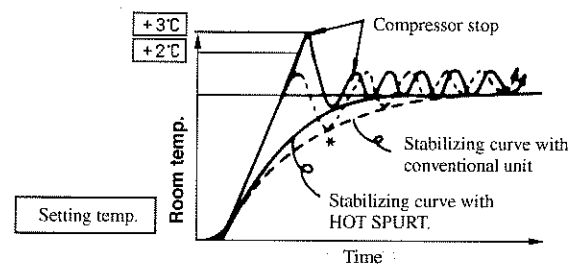

(c) HOT KEEP

1) Cold draft prevention (I)

- a) **Operation timing:** While defrosting operation
- b) **Function:** The indoor fan is stopped and RUN (HOT KEEP) lamp flashing.

2) Cold draft prevention (II)

- a) **Operation timing:** When thermostat is switched to "off".
- b) **Function:** The indoor fan operates as shown below, and after the passage of a period of either 5 minutes return to thermo. Control at speed 1 operation.

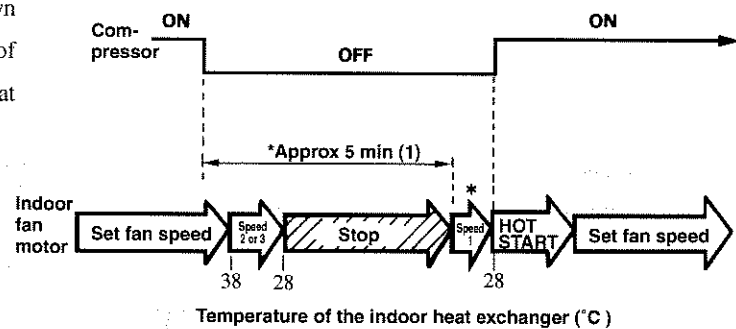

Notes (1) When the thermostat does not reset within 5 minutes, reset it by operating the indoor fan motor at speed 1.

(2) The * marked speed 1 operation shows the case in which the thermostat is switched to off. While the defrosting operation the * marked operation are not performed.

(11) DRY operation

- (a) Choose the appropriate operation block area by the difference between room temperature and thermostat setting temperature as shown below.

• Operation block area

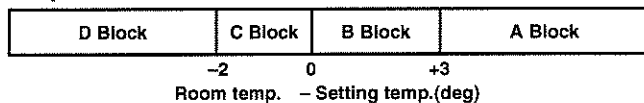

- (b) Start up operation

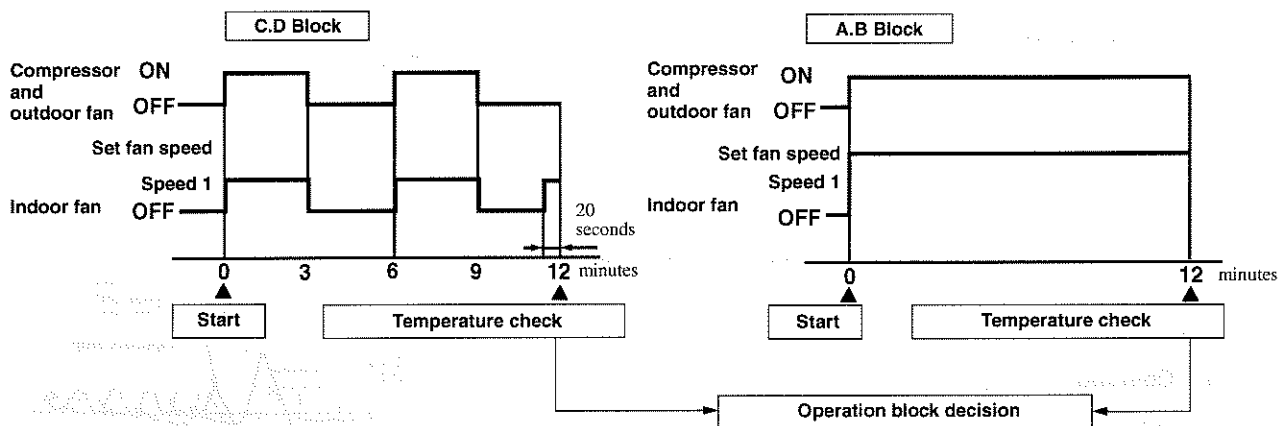

Note (1) Thermostat operation is performed in A, B Block. When compressor and indoor fan stop by thermostat operation within 12 minutes from start, temperature check is performed by operating indoor fan at speed 1 for 20 seconds before finishing 12 minutes and allowing decision of next operation block.

- (c) DRY operation

After finishing start up operation described in (b) above, thermal dry operation is performed at 8 minutes intervals, according to the difference between room temperature and thermostat setting temperature as shown below.

Beside, 1 cycle of this operating time consists of 8 minutes, 7 cycle operation is performed then.

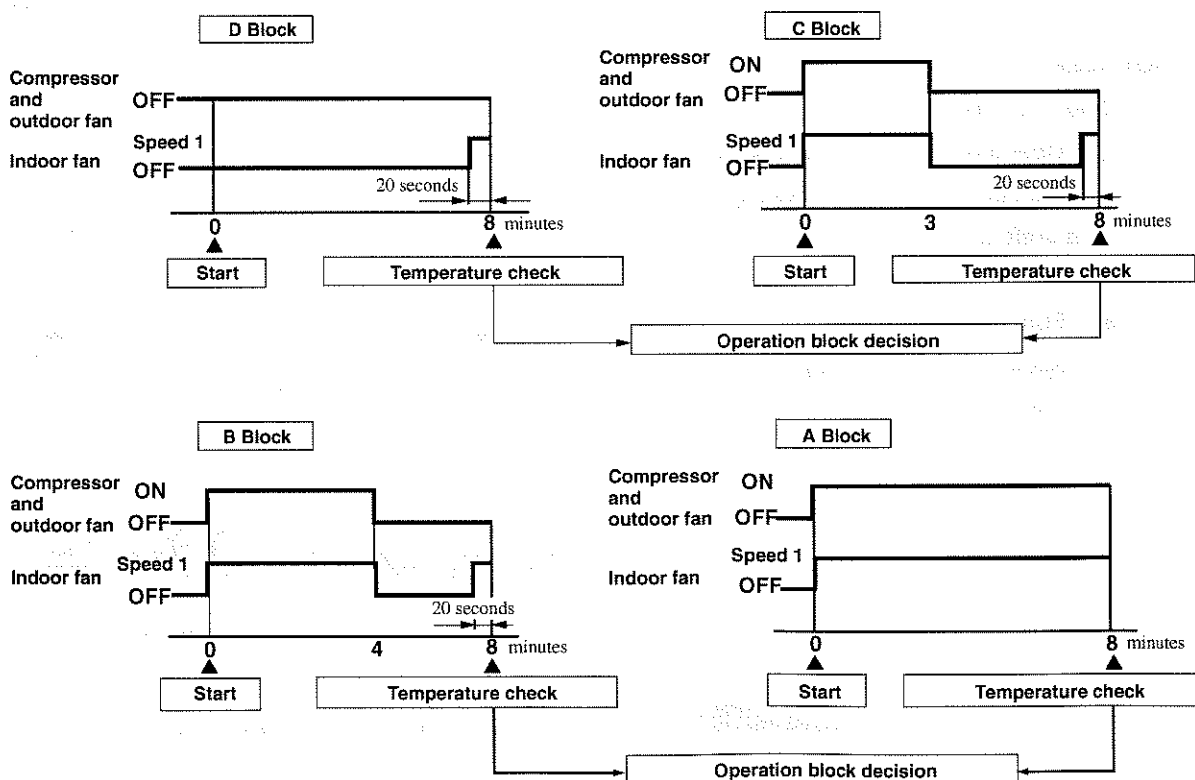

(12) Dew condensation prevention control for cooling operation

This prevents dew condensation, in the indoor unit, from occurring.

- (a) **Operating condition:** when 52C is kept ON for 30 min. after the unit starts operation.
- (b) **Operation content:** forces the indoor fan to change from Speed 1 to Speed 2.
- (c) **Resetting condition:** When 52C is off, or when dew condensation prevention control has been operating continuously for 30 minutes.

(13) Frost prevention for indoor heat exchanger [Preventing frost accumulation on the indoor heat exchanger]

During the Cooling or Dry operation in low room air temp. condition, evaporating temperature will decrease and consequently indoor heat exchanger sometimes gets clogged with frost (or ice).

In order to prevent this trouble, compressor is stopped by under mentioned condition by indoor heat exchanger thermistor (Th2) and timer (built into micro computer circuit) functions.

Also indoor fan is changed over to Lo speed.

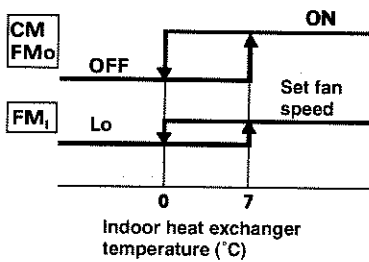

CM, FM_o stoppage condition

- ① Temperature of heat exchanger is 0°C or lower.
- ② As least 10 minutes has passed since the compressor started.

CM, FM_o re-starting condition

- ① Temperature of heat exchanger is 7°C or higher.
- ② As least 3 minutes has passed since the compressor stopped.

(14) Microcomputer Controlled Timely Defrosting Operation

◆ **SRK28HJ**

- (a) **Defrost Start**
Changes in the difference in temperature between the intake air temperature and the indoor heat exchanger temperature causes frost to build up, at which time defrosting begins. However, defrosting will not occur when the total compressor operation time or time after defrosting has ended is 40 minutes.
- (b) **Defrost End**
After defrosting has continued for 3 minutes or 7 minutes (when thermal is off before defrosting), defrosting will end and heating will begin again.

Device operation during defrosting

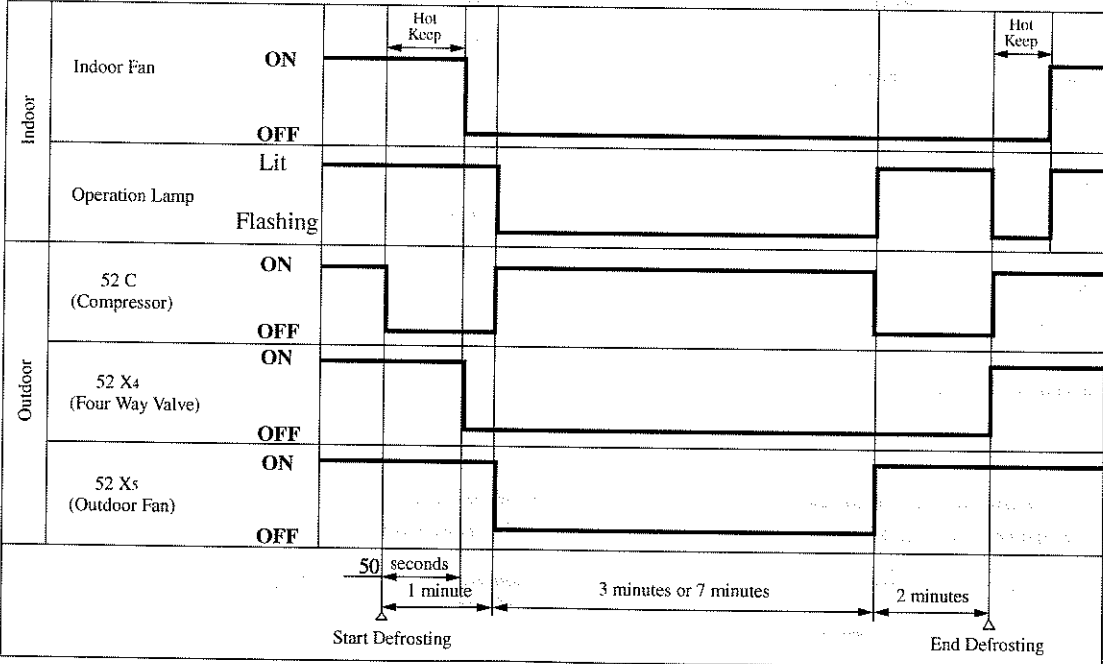

◆ SRK40HJ

(a) Defrost Start

Changes in the difference in temperature between the intake air temperature and the indoor heat exchanger temperature causes frost to build up, at which time defrosting begins. However, defrosting will not occur when the total compressor operation time or time after defrosting has ended is 40 minutes.

(b) Defrost End (heat exchanger temperature or timer)

- 1) What the heat exchanger temperature (detected by 23DH) reaches the value given below, defrosting is ended and heating operation is returned to. Preset values: 14C°
- 2) Operation will also return to heating operation when more then 10 minutes has passed since the starting of defrosting operation.

Device operation during defrosting

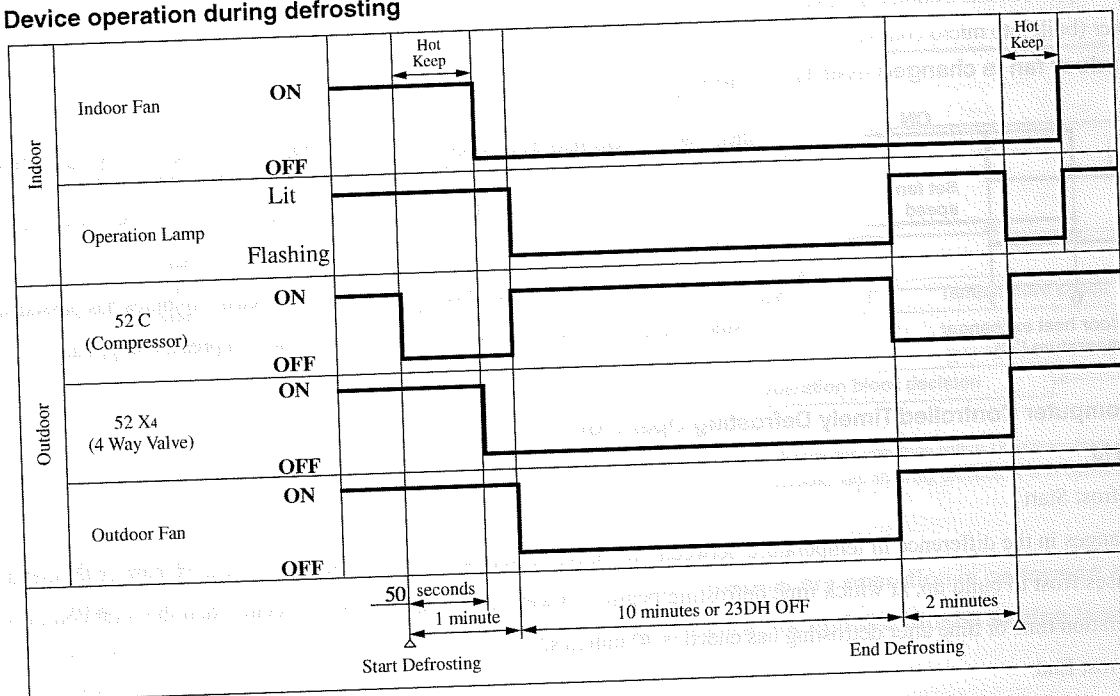

(15) Forced defrosting

To test forced defrosting in the operation test mode, the unit may be operated once in the forced defrost mode as shown below.

- (1) Temporarily turn off the power source and then perform the following operation using the remote controller within 20 seconds after the power is turned back on.

Operation : Run Air flow : Swing
 Fan speed : Low Timer switch : On timer (⊕)
 Operation setting : Heating On time : 3H
 Temperature setting : 19

(2) Defrost end

◆ SRK28HJ

When remote control operation is performed, defrosting will begin after the 3 minute timer operation ends. After 3 minutes all operations will stop.

◆ SRK40HJ

When the remote control operation is performed, forced defrosting will start for 1 minute after the three minute timer operation ends. After that the defrost thermostat(23DH) will either turn OFF or the operation will stop after 10 minutes.

(16) High-Pressure Control

The indoor heat exchanger sensor detection temperature controls the outdoor fan and compressor.

◆ SRK28HJ

- When the Indoor Heat Exchanger Temperature is $\geq 54^{\circ}\text{C}$

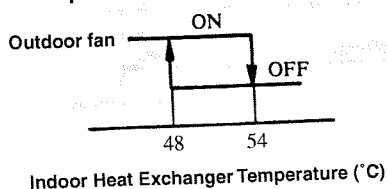

- When the Indoor Heat Exchanger Temperature is $\geq 61^{\circ}\text{C}$

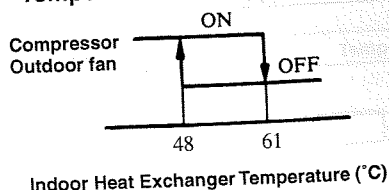

◆ SRK40HJ

- When the indoor heat exchanger temperature is $\geq 61^{\circ}\text{C}$

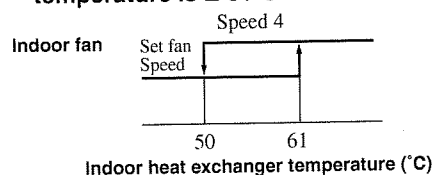

- When the indoor heat exchanger temperature is $\geq 64^{\circ}\text{C}$

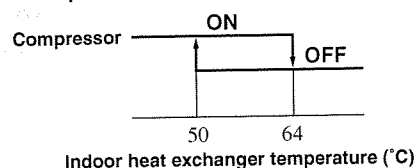

(17) Heating operation overload protection (40 type only)

During heating operation in overload condition (room outside air temperature is considerably high), in order to protect the unit, the outdoor fan is controlled by the pressure switch (63H).

(a) Outdoor fan control

High pressures are prevented and extreme heat absorption controlled by turning the outdoor fan ON and OFF with the pressure switch.

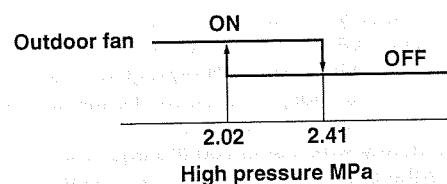

(18) High power operation (Remote controller "HI POWER" button on)

The indoor unit fan rotates at speed 4 for 15 minutes, and carries out continuous cooling and heating.

(19) Economy operation (Remote controller "ECONO" button on)

(a) Cooling economy operation

The indoor unit fan operates 2°C higher than the set temperature at speed 1.

(b) Thermal dry economy operation

Thermal dry operation carried out at 2°C higher than the set temperature.

(c) Heating economy operation

The indoor unit fan operates 2°C lower than the set temperature at speed 2.

(20) Self diagnosis function

When something abnormal happens on the outdoor unit, indoor unit fan motor and each thermistor (heat exchanger, room temperature,) it will be indicated by flashing lamps.

- (a) **Abnormality of outdoor unit:** TIMER lamp will flashing when 5 minutes after it has been operated with the compressor ON (52°C ON) the temperature on heat exchanger thermistor will not go below 25°C for more than 20 minutes for cooling and will not go over 30°C for more than 20 minutes for heating.

(The compressor will stop when cooling more than 20 minutes after flashing of the lamp, or heating above 25°C and below 30°C .)

- (b) **Abnormality of indoor fan motor:** When the indoor fan motor goes ON during air conditioner operation, if the fan speed remains at 300 rpm or lower continuously for 30 seconds or longer, the entire system shuts down and the abnormal indication is displayed. (The timer lamp lights up and the run lamp flashes 6 times.)

- (c) **Abnormality of heat exchanger thermistor:** RUN lamp will flashing when the input temperature of the heat exchanger thermistor measures less than -20°C for more than 3 seconds with the air-conditioner "OFF". (will not flashing during operation)

- (d) **Abnormality room temperature thermistor:** RUN lamp will flashing when the input temperature of the room temperature thermistor measures less than -20°C for more than 3 seconds with the air-conditioner "OFF". (will not flashing during operation)

Note (1) If the above abnormalities happen concurrently, the lamp will flashing in the order of item number (a) through (d) above.

5 APPLICATION DATA



SAFETY PRECAUTIONS

- Please read these "Safety Precautions" first then accurately execute the installation work.
- Though the precautionary points indicated herein are divided under two headings, **⚠WARNING** and **⚠CAUTION**, those points which are related to the strong possibility of an installation done in error resulting in death or serious injury are listed in the **⚠WARNING** section. However, there is also a possibility of serious consequences in relationship to the points listed in the **⚠CAUTION** section as well. In either case, important safety related information is indicated, so by all means, properly observe all that is mentioned.
- After completing the installation, along with confirming that no abnormalities were seen from the operation tests, please explain operating methods as well as maintenance methods to the user (customer) of this equipment, based on the owner's manual. Moreover, ask the customer to keep this sheet together with the owner's manual.

⚠WARNING

- To disconnect the appliance from the mains supply this appliance must be connected to the mains by means of a circuit breaker or a switch (use a recognized 20A) with a contact separation of at least 3mm.
- The appliance shall be installed in accordance with national wiring regulations.
- This system should be applied to places as households, residences and the like. Application to inferior environment such as engineering shop could cause equipment malfunction.
- Please entrust installation to either the company which sold you the equipment or to a professional contractor. Defects from improper installations can be the cause of water leakage, electric shocks and fires.
- Execute the installation accurately, based on following the installation manual. Again, improper installations can result in water leakage, electric shocks and fires.
- For installation, confirm that the installation site can sufficiently support heavy weight. When strength is insufficient, injury can result from a falling of the unit.
- For electrical work, please see that a licensed electrician executes the work while following the safety standards related to electrical equipment, and local regulations as well as the installation instructions, and that only exclusive use circuits are used. Insufficient power source circuit capacity and defective installment execution can be the cause of electric shocks and fires.
- Accurately connect wiring using the proper cable, and insure that the external force of the cable is not conducted to the terminal connection part, through properly securing it improper connection or securing can result in heat generation or fire.
- Take care that wiring does not rise upward, and accurately install the lid/service panel. It's improper installation can also result heat generation or fire.
- When setting up or moving the location of the air conditioner, do not mix air etc. or anything other than the designated refrigerant (R22) within the refrigeration cycle. Rupture and injury caused by abnormal high pressure can result from such mixing.
- Always use accessory parts and authorized parts for installation construction. Using parts not authorized by this company can result in water leakage, electric shock, fire and refrigerant leakage.
- Ventilate the work area when refrigerant leaks during the operation. Coming in contact with fire, refrigerant could generate toxic gas. 
- Confirm after the foundation construction work that refrigerant does not leak. If coming in contact with fire of a fan heater, a stove or movable cooking stove, etc., refrigerant leaking in the room could generate toxic gas.

⚠CAUTION

- Execute proper grounding. Do not connect the ground wire to a gas pipe, water pipe, lightning rod or a telephone ground wire. 
Improper placement of ground wires can result in electric shock.
- The installation of an earth leakage breaker is necessary depending on the established location of the unit. No installing an earth leakage breaker may result in electric shock.
- Do not install the unit where there is a concern about leakage of combustible gas. 
The rare even of leaked gas collecting around the unit could result in an outbreak of fire.
- For the drain pipe, follow the installation manual to insure that it allows proper drainage and thermally insulate it to prevent condensation. Inadequate plumbing can result in water leakage and water damage to interior items.
- Install the outdoor unit so that the aluminum fins on the air heat exchanger cannot be touched. Failure to observe this may result in injury.
- Do not place objects near the outdoor unit or allow leaves to gather around the unit. If there are objects or leaves around the outdoor unit, small animals may enter unit and contact electrical parts resulting in break down, emission of smoke or flame.

5.1 Selection of location for installation

(1) Indoor unit

- (a) Where there is no obstructions to the air flow and where the cooled air can be evenly distributed.
- (b) A solid place where the unit or the wall will not vibrate.
- (c) A place where there will be enough space for servicing. (Where space mentioned below can be secured)
- (d) Where wiring and the piping work will be easy to conduct.
- (e) The place where receiving part is not exposed to the direct rays of the sun or the strong rays of the street lighting.

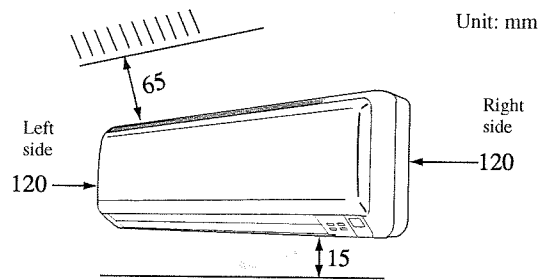

(2) Outdoor unit

- (a) A place where good air circulation can be obtained.
- (b) A place where the exhausted air will not be sucked in for the second time.
- (c) A place where the unit will not be affected by other heat sources. (When there are several units installed or another heat source)
- (d) Do not install the unit near the seaside, or where there is possibility of chlorine gas generation.
- (e) A place where discharged hot and cold air or unit's operating sound will not be nuisance to the neighbourhood.
- (f) A place where servicing space can be secured.
- (g) A place where vibration will not be enlarge.
- (h) In heating operation, snow deposit on the heat-exchanger of outdoor unit must be prevented for keeping the normal performance capacity.
 - (i) Snow-hood on outdoor unit as in drawing, will reduce the frequency of defrost operation.

When installing the snow hood, take care so that the air outlet of the snow hood will not face directly into the most windy direction.
 - (ii) Design the base higher than possible snow deposit.

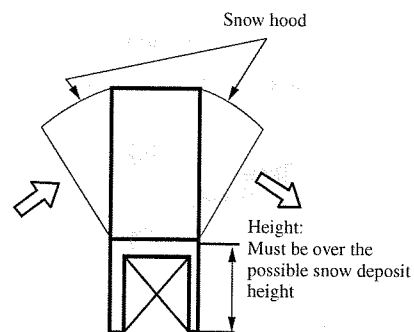
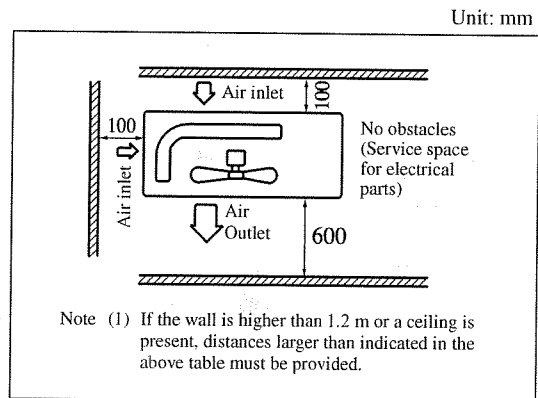

(3) Limitations for one way piping length and vertical height difference.

Item	Model	All models
One way piping length (ℓ)		15
Vertical height difference (h)	Outdoor unit is lower	5 m
	Outdoor unit is higher	5 m

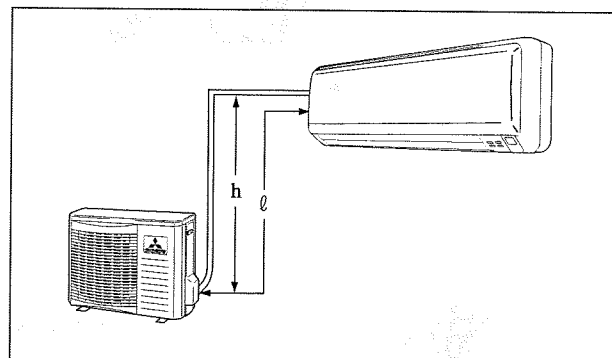

5.2 Installation of indoor unit

(1) Installation if installation board

(a) Fixing of installation board

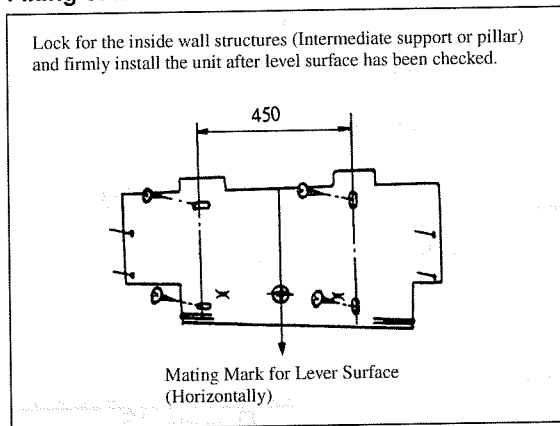

Adjustment of the installation board in the horizontal direction is to be conducted with four screws in a temporary tightened state.

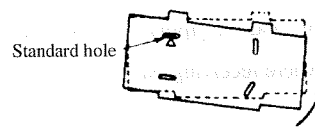

Adjust so that board will be level by turning the board with the standard hole as the center.

(b) Fixing method of installation board

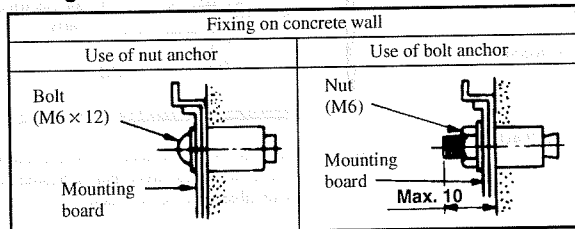

(2) Drilling the and installation of sleeve

(a) Drill a hole with ø65 whole core drill

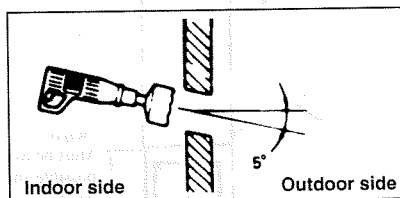

Note (1) Drill a hole with incline of 5 degree from indoor side to outdoor side.

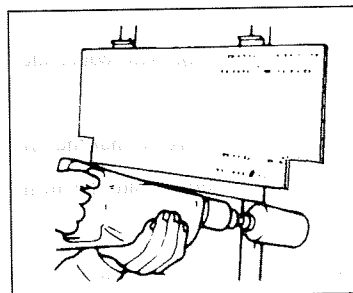

(b) Adjusting sleeve length (Option parts)

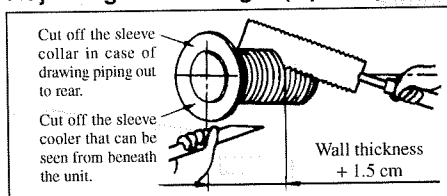

(c) Install the sleeve

(Inserting sleeve)

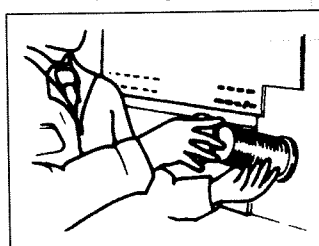

(*Sleeve + *Inclined + *Sealing plate)

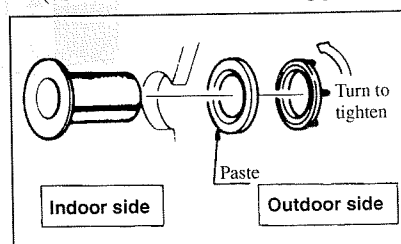

View of sleeve when installed

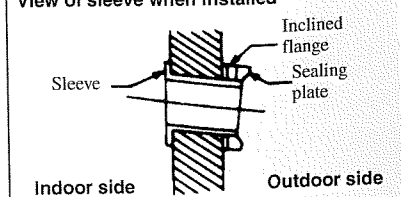

(3) Preparation of indoor unit

(a) Mounting of connecting wires

- (i) Remove lid.
- (ii) Remove cover, terminal block cover.
- (iii) Connect the connection wire securely to the terminal block.
- ① Affix the connection wire securely to the terminal block. If the wire is not affixed completely, contact will be poor, and it is dangerous as the terminal block may heat up and catch fire.
- ② Take care not to confuse the terminal numbers for indoor and outdoor connections.
- ③ Affix the connection wire using the wiring clamp.
- (iv) Attach the terminal back cover.
- (v) Attach the lid.

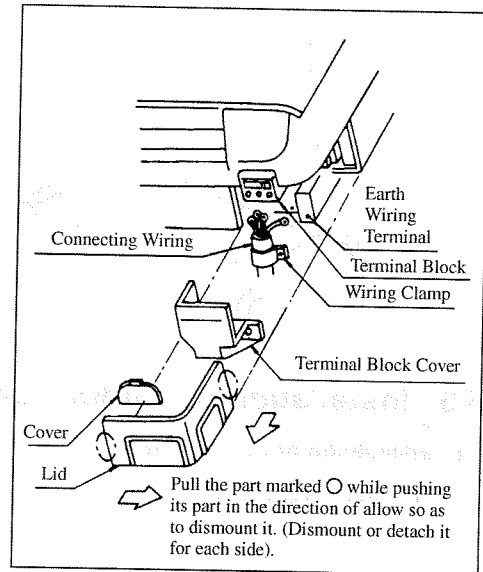

Use cables for interconnection wiring to avoid loosening of the wires.

CENELEC code for cables Required field cables:

- H05 RNR3G1.5 (Example)
- H Harmonized cable type
- 05 300/500 volts
- R Natural-and/or synth. rubber wire insulation
- N Polychloroprene rubber conductors insulation
- R Stranded core
- 3or5 Number of conductors
- G One conductor of the cable is the earth conductor (yellow/green)
- 1.5 Section of copper wire (mm²)

type	Heat pump type
① BROWN	○
② BLUE	○
③ BLACK	○
④ GREEN	○
⊕ / YELLOW / GREEN	○

- (b) **Protective taping** (Protect the cable with tape at the section where the cable passes through the hole opened on the wall.)
- (c) **Forming of pipe** (Holding down the pipe at the root, change the pipe direction, extend it and adjust according to the circumstance.)

[When the pipe is extended to left and taken out from the rear center]

(Drain pipe relocation procedure)

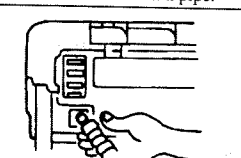
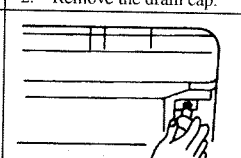
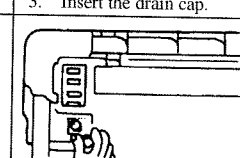
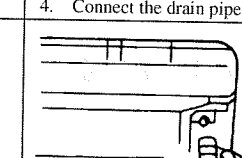
1. Remove the drain pipe.	2. Remove the drain cap.	3. Insert the drain cap.	4. Connect the drain pipe.
			

- Loosen the spring clamp to remove.
- Remove by hand or use cutting pliers, etc.
- Securely insert the drain cap removed in the step 2.
Note: If it is inserted insufficiently, water leakage could result.
- Loosen the spring clamp and securely insert the drain pipe.
Note: If it is inserted insufficiently, water leakage could result.

- When arranging the pipe through a hole opened at the center, open the knockout hole using nippers, etc.

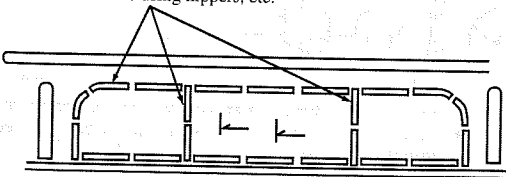

Note (1) It is designed to collect moisture accumulated on the rear face in the drain pan. Be sure not to accommodate the power cable, etc. above the chute.

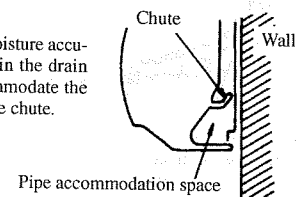

(4) Installation of indoor unit

- Hang the upper portion of the unit rear cover on the mounting board, and then magnet on the lower unit portion will pull to fix the unit.
- Be sure not to leave any trap on the drain pipe.

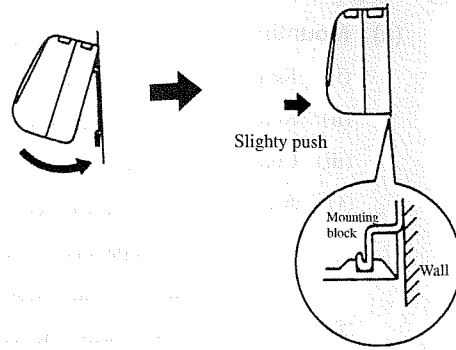
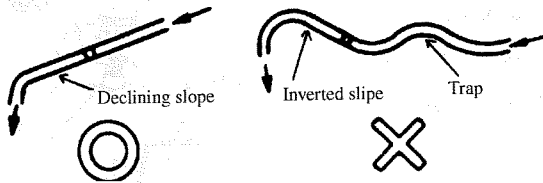

5.3 Installation of outdoor unit

(1) Installation of outdoor unit

- Make sure that sufficient space for installation and service is secured.
- Fix the leg sections of the unit on a firm base which will not play.
Attach cushion pads, etc. between the unit and the mounting fixtures not to transmit vibration to the building.
- Attach a drain elbow, etc. under the drain port of the bottom plate to guide drain water. (Drain elbow should not be used where days when temperature drops below 0°C continue for several days. Draining may be disturbed by frozen water.)
- When installing the unit at a higher place or where it could be toppled with strong winds, secure the unit firmly with foundation bolts, wire, etc.

(2) Connection of indoor and outdoor connecting wiring

- Connect the wiring according to the number of the indoor terminal block. (Mis-wiring may cause the burning damage, and make sure to connect correctly.)

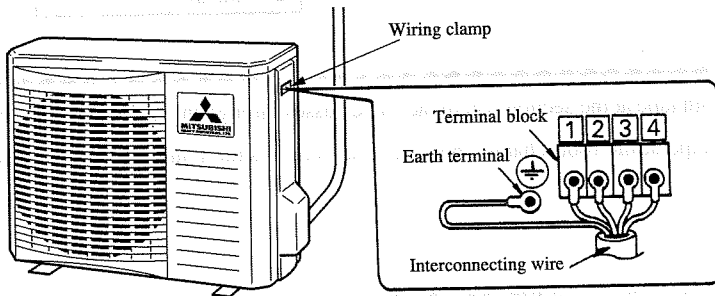

type	Heat pump type
① BROWN	○
② BLUE	○
③ BLACK	○
④ GREEN	○
YELLOW	○
⊕ GREEN	○

5.4 Refrigerant piping

(1) Preparation

Keep the openings of the pipes covered with tapes etc. to prevent dust, sand, etc. from entering them.

Indoor unit side

- Remove the flared nuts. (on both liquid and gas sides)

Outdoor unit side

- Remove the flared nuts. (on both liquid and gas sides)

Dimension A	
Liquid side (φ6.35):	9-9.5 dia
Gas side (φ9.52):	13.2-14 dia
(φ12.7):	16.2-17 dia

- Install the removed flared nuts to the pipes to be connected, then flare the pipes.

(2) Connection of refrigerant piping

Indoor unit side

- Connect firmly gas and liquid side pipings by Torque wrench.

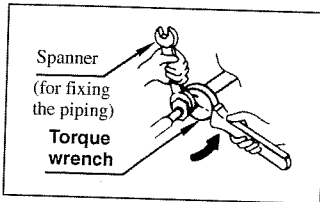

- Specified torquing value:

Liquid side (ø6.35) : 15.7~19.6 N·m(1.6~2.0 kgf·m)

Gas side (ø9.52) : 29.4~39.2 N·m(3.0~4.0 kgf·m)

Gas side (ø12.7) : 39.2~49.0 N·m(4.0~5.0 kgf·m)

Outdoor unit side

- Connect firmly gas and liquid side pipings by Torque wrench.

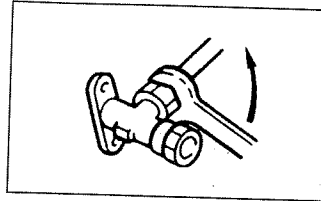

- Specified torquing value:

Liquid side (ø6.35): 15.7~19.6 N·m(1.6~2.0 kgf·m)

Gas side (ø9.52) : 29.4~39.2 N·m(3.0~4.0 kgf·m)

Gas side (ø12.7) : 39.2~49.0 N·m(4.0~5.0 kgf·m)

- Use one more spanner to fix the valve.

- Always use a Torque wrench and back up spanner to tighten the flare nut.

(3) Air purge

- Tighten all flare nuts in the pipings both indoor and outside wall so as not to cause leak.
- Connect service valve, charge hose, manifold valve and vacuum pump as is illustrated below.
- Open manifold valve handle Lo to its full width, and perform vacuum or evacuation.

Continue the vacuum or evacuation operation for 15 minutes or more and check to see that the vacuum gauge reads -0.1MPa (-76cm Hg).

- After completing vacuum operation, fully open service valve (Both gas and liquid sides) with hexagon headed wrench.
- Check for possible leakage of gas in the connection parts of both indoor and outdoor.

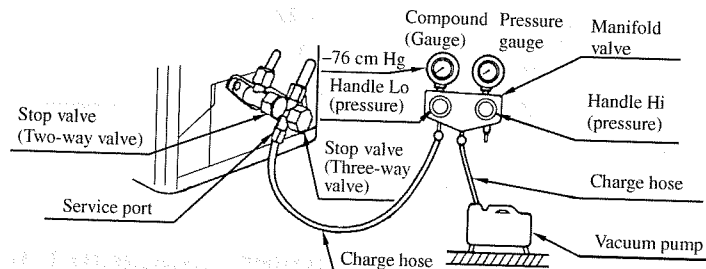

Additional refrigerant charge

When refrigerant piping exceeds 5m conduct additional refrigerant charge after refrigerant sweeping.

5m over 15m Additional charge amount per meter = 30g/m

[Example]

How much amount of additional charge for 15m piping?

$(15 - 5)m \times 30g/m = 300g$ 300g for additional charge

(4) Insulation of connecting portion

- Cover the connection portion of the refrigerant piping with the pipe cover and seal them.
If neglecting to do so, moisture occurs on the piping and water will drip out.

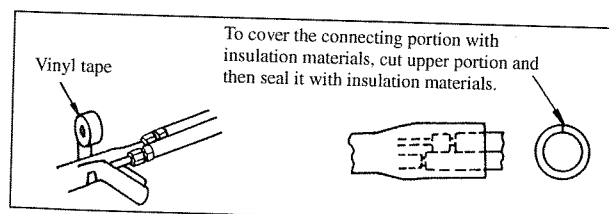

- 2) Finishing and fixing
 - a) Tie up the piping with wrapping tape, and shape it so that it conforms to which the pipe is attached.
 - b) Fix them with clamps as right figure.

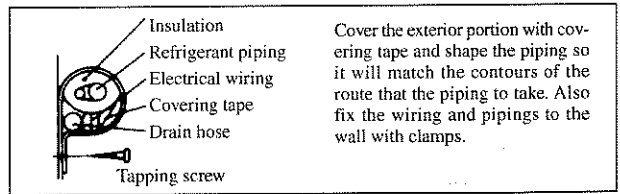

5.5 Test run

- (1) Conduct trial run after confirming that there is no gas leaks.
- (2) When conducting trial run set the remote controller thermostat to continuous operation position. However when the power source is cut off or when the unit's operation switch is turned off or was turned to fan operation position, the unit will not go into operation in order to protect the compressor.
- (3) Insert in electric plug into the electric outlet and make sure that it is not loose.
 - (a) When there is something wrong with the electric outlet and if the insertion of the electric plug is insufficient, there may occur a burn out.
 - (b) It is very important to be careful of above when plugging in the unit to an already furnished electrical outlet.
- (4) Explain to the customer on the correct usage of the air conditioner in simple layman's terms.
- (5) Make sure that drain flows properly.
- (6) **Standard operation data** (220/230V)

Item	Model	SRK28HJ	SRK40HJ
High pressure MPa	Cooling	-	-
	Heating	1.67~1.86	1.67~1.86
Low pressure MPa	Cooling	0.39~0.49	0.44~0.54
	Heating	-	-
Temp. difference between return air and supply air (°C)	Cooling	11 ~ 15	13 ~ 16
	Heating	17 ~ 22	20 ~ 30
Running current (A)	Cooling	4.3	6.6
	Heating	4.0	6.4

Note (1) The data are measured at following conditions.
 Ambient air temperature
 Indoor side: Cooling ... 27°C DB, 19°C WB, Heating ... 20°C DB
 Outdoor side: Cooling ... 35°C DB, 24°C WB, Heating ... 7°C DB, 6°C WB

5.6 Precautions for wireless remote controller installation and operation

- (1) Wireless remote controller covers the following distances:
 - (a) When operating facing the air conditioner:

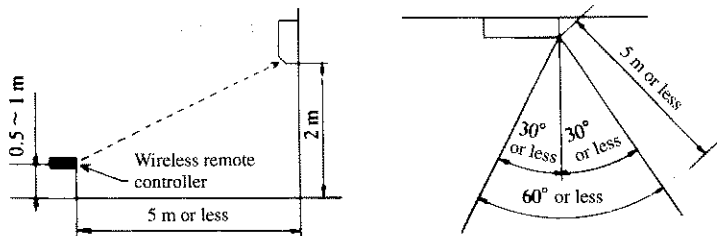

- Notes (1) The remote controller is correctly facing the sensing element of the air conditioner when being manipulated.
 (2) The typical coverage is indicated (in the left illustration). It may be more or less depending on the installation.
 (3) The coverage may be less or even nil. If the sensing element is exposed to strong light, such as direct sunlight, illumination, etc., or dust is deposited on it or it is used behind a curtain, etc.

- (b) When manipulating the remote controller mounted on a wall:

Make sure that it works normally (i.e., transmission/reception signal is audible) before mounting.

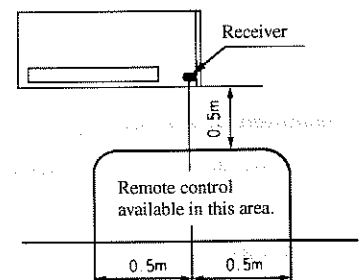

6 MAINTENANCE DATA

6.1 Trouble shooting

(1) Trouble shooting to be performed prior to exchanging PCB, (Printed circuit board) [Common to all models]

All the models described in this chapter are controlled by a microcomputer. When providing maintenance service to customers it is necessary to understand the function controlled by a micro computer thoroughly, so as not to mistakenly identify correct operations as mis-operations. It is also necessary to perform the following simple checks before conducting detailed checks or exchanging printed circuit board.

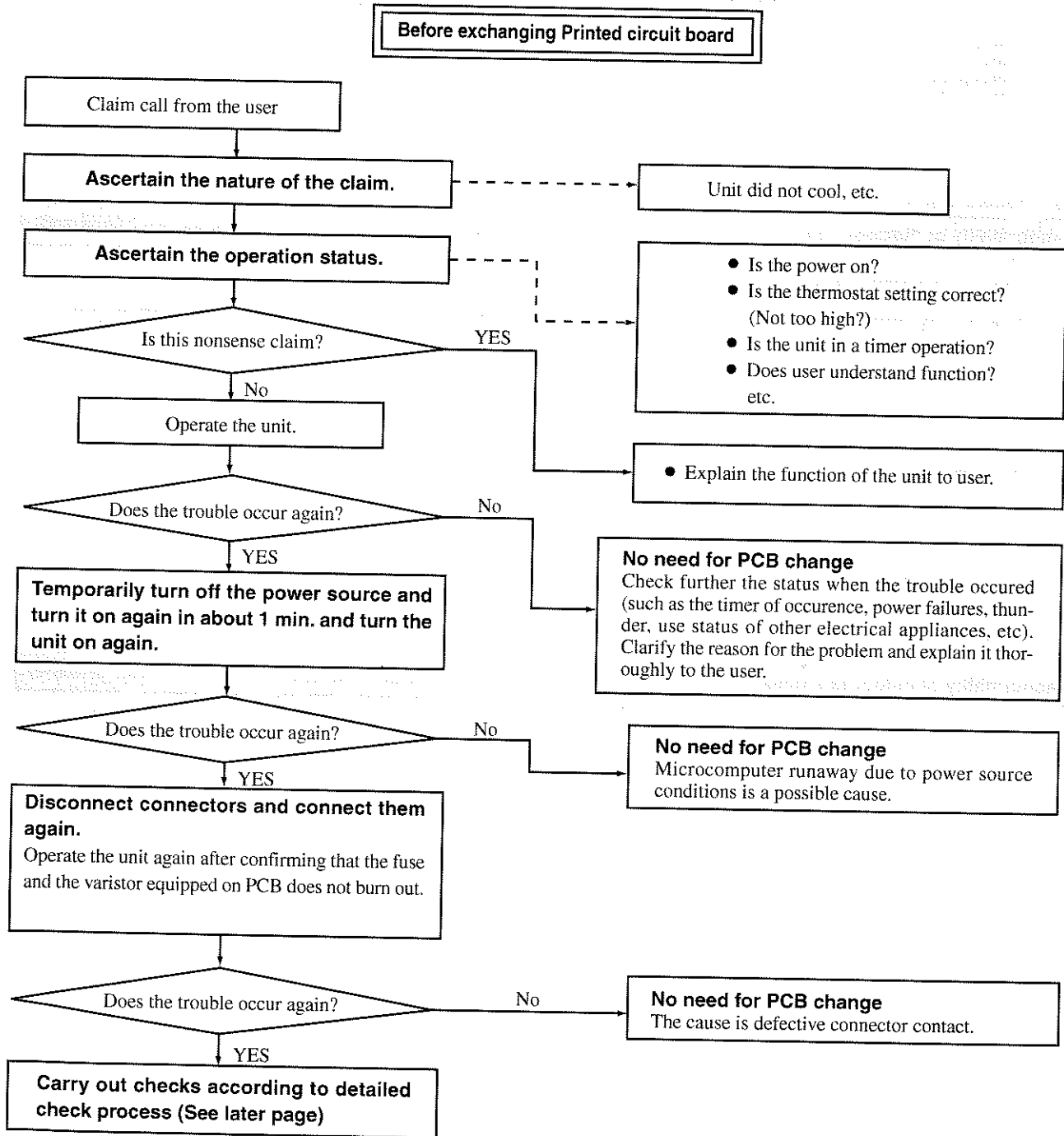

(2) Indication of Self Diagnosis (Indoor unit)

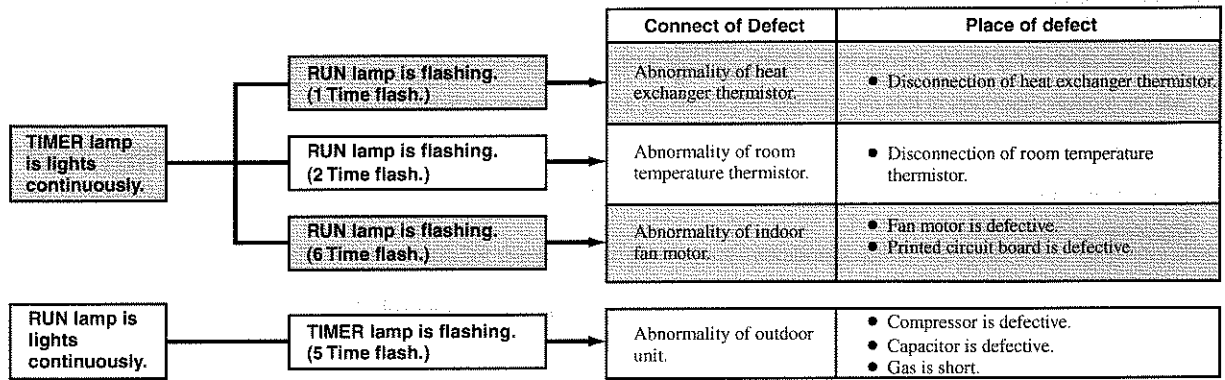

(3) Troubleshooting

Abnormality of outdoor unit [Compressor malfunction of insufficient gas (refrigerant)]

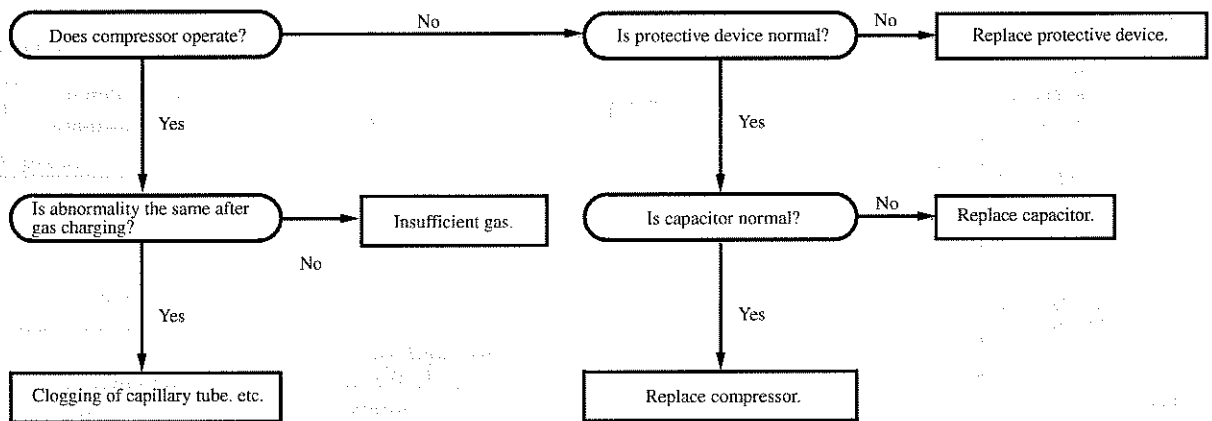

Abnormality of indoor fan motor (Fan motor defective, printed circuit board defective)

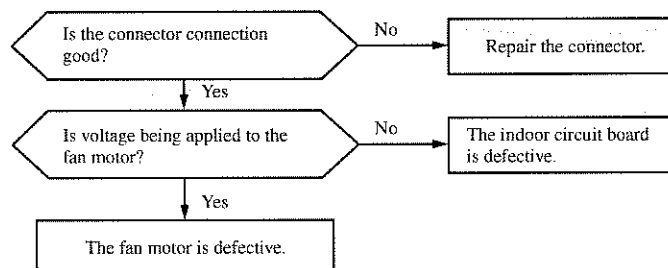

Anormality of thermistor

Disconnection of thermistor and defective connection of connector

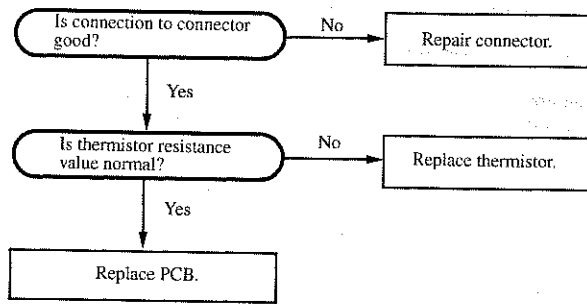
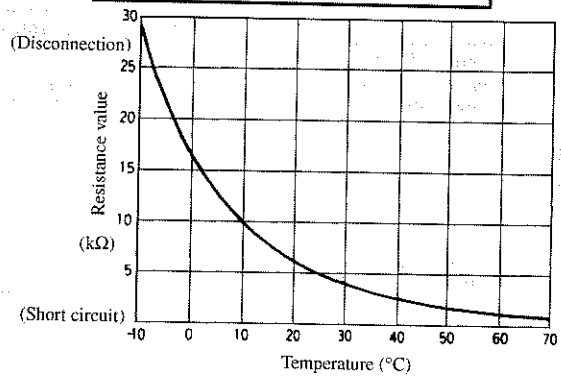
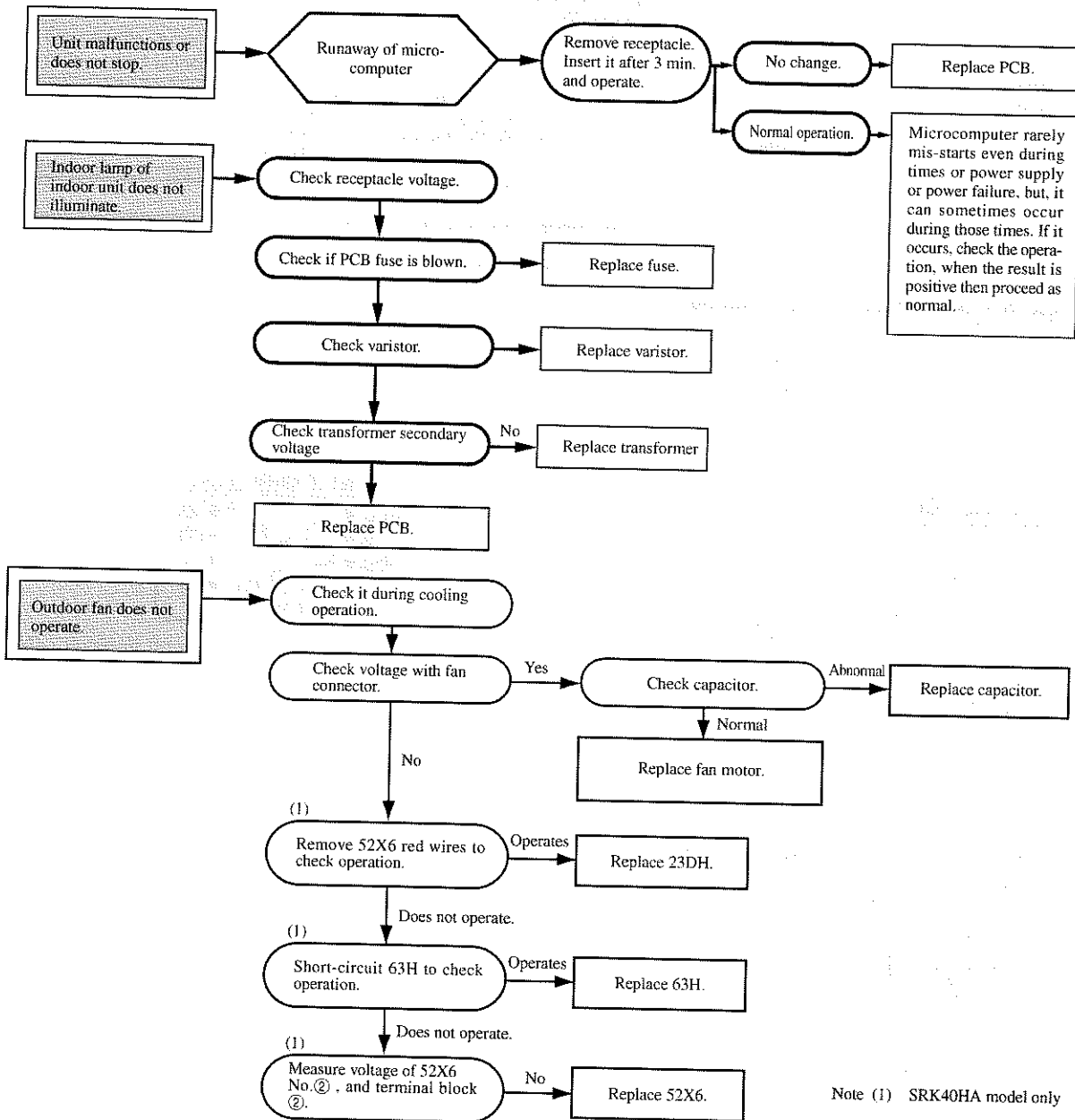

Chart for thermistor temperature resistance characteristics



(4) Trouble Diagnostic Procedures



Note (1) SRK40HA model only

(5) Trouble shooting chart for the room temperature thermistor (Th1), heat exchanger thermistor (Th2) and defrost thermostat (23DH)

Unit	Thermistor	Operation	Function	
			Short circuit	Broken connection
Indoor unit	Room temperature thermistor ⁽¹⁾ (Th1) except for "continuous" thermal setting.	Cooling	Continuous Cooling operation <ul style="list-style-type: none"> Cannot be turned ON/OFF by thermostat When FMi is on, "AUTO" is continuously Hi 	Cooling will not operate <ul style="list-style-type: none"> FMi : continuous operation CM,FMo: stopped
		Heating	Heating will not operate (CM, FMo, FMi all stopped)	Continuous heating operation. <ul style="list-style-type: none"> Cannot be turned ON/OFF by thermostat When FMi is on, "AUTO" is continuously Hi
	Heat exchanger thermistor (Th2)	Cooling	Cooling will not operate.	Cooling will operate <ul style="list-style-type: none"> Heat exchanger frost preventer begins to operate Cools alternately for 10 minutes, stopping for 3 minutes.
		Heating	Heating will not operate <ul style="list-style-type: none"> Heating overload protect begins to operate When FM is on, "AUTO" is continuously Hi CM, FMo are stopped 	Heating will not operate normally <ul style="list-style-type: none"> CM, FMo are ON FMi is OFF Hot keep lamp illuminated
Outdoor unit	Defrost thermostat (23DH)	Cooling	Cooling will not operate (blown breaker) <ul style="list-style-type: none"> CM, FMi are ON FMo is OFF 	No effect
		Heating	Heating will not operate normally (The defrosting will operate normally, but 23DH reset is not possible. De frosts for 10 minutes)	Heating will operate. <ul style="list-style-type: none"> Unable to defrost⁽²⁾ Will not operate for very long when outside air temperature is low

Notes

(1) When the room temperature thermistor (Th1) will not operate normally. Cooling or heating operation may be run continuously by putting the thermostat setting on "CONTINUOUS".

(2) When switching to the defrost cycle, 23DH opens (broken connection), the mechanism resets to heating, and defrosting will not operate.

(6) How to make sure of remote controller

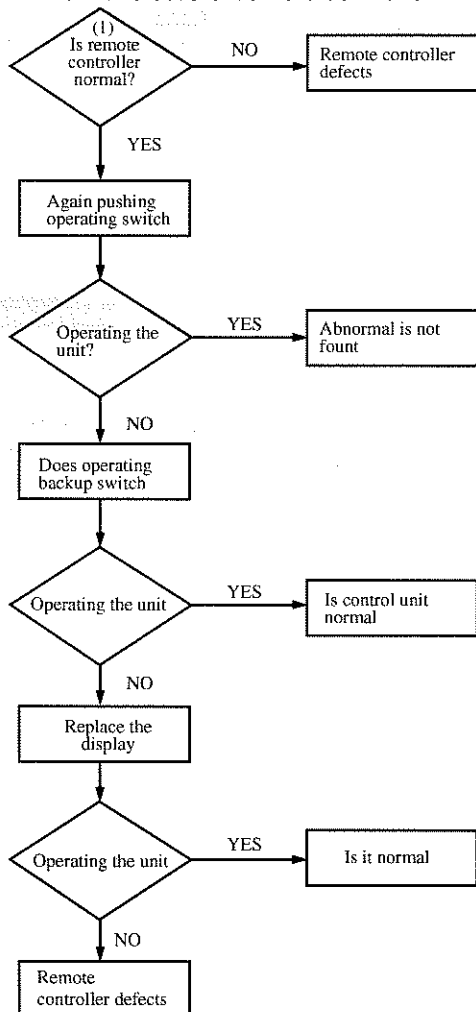

Note (1) How to check the remote controller

(a) Press the reset switch of remote controller.

(b) If the salmost normal if entire display of remote controller is shown after \square indication.

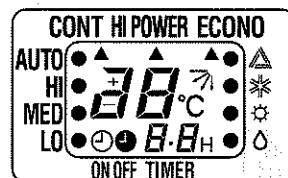

6.2 Servicing

(1) Evacuation

The evacuation is an procedure to purge impurities noncondensable gas, air, moisture from the refrigerant equipment by using a vacuum pump. Since the refrigerant R22 is very insoluble in water, even a small amount of moisture left in the refrigerant equipment will freeze, causing what is called water clogging.

• Evacuation procedure

- Check to ensure that there is no internal pressure in the unit. If there is an internal pressure, it should be relieved through the check joint.
- Connect the service hoses of the gauge manifold to the check joint of the gas & liquid piping.
- Connect a vacuum pump to the charge hose (A). Repeat evacuation in the following sequence.

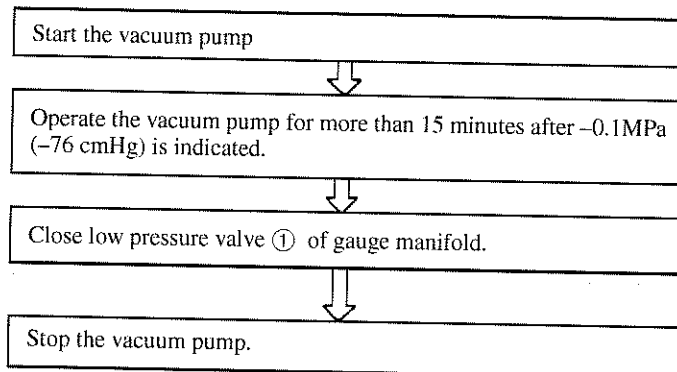

- Notes (1) Do not use the refrigerant pressure to expel air.
(2) Do not use the compressor for evacuation.
(3) Do not operate the compressor in the vacuum condition.

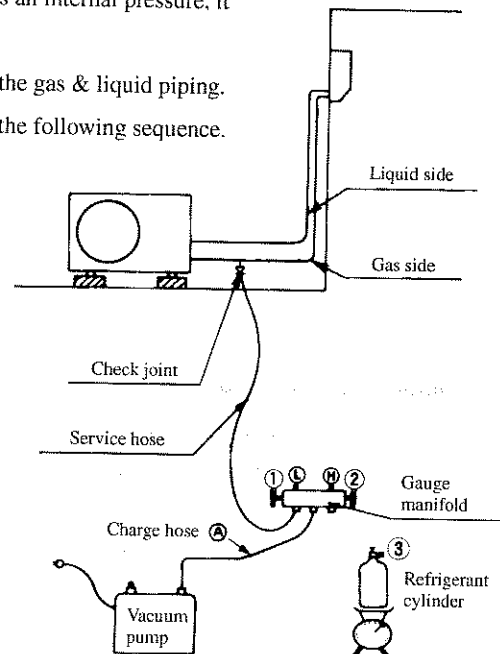

(2) Refrigerant charge

- Discharge refrigerant entirely from the unit and evacuate the unit.

Note: Addition of refrigerant without evacuation is unreasonable, because it will result in low charge or overcharge.

- Keep the gauge manifold and connect a refrigerant cylinder to the unit.
- Record the weight of the refrigerant cylinder on the balance. This is necessary for making sure of the charged refrigerant amount.
- Purge air from the charge hose (A).
Firstly loose the connecting portion of the charge hose (A) at the gauge manifold side and open the valve ③ for a few seconds, and then immediately retighten it after observing that gas is blow out from the loosened portion.
- Open the valve ① and ③ after discharging air from the charge hose (A), then the gas refrigerant begins flowing from the cylinder into the unit. Be sure to erect the refrigerant cylinder upright to let gas refrigerant flow into the unit.
- When refrigerant has been charged into the system to some extent, refrigerant flow becomes stagnant, when that happens, start the compressor in cooling cycle until the unit is filled with gas to the specified weight.
- Making sure of the refrigerant amount, close the valve ③.
- Disconnect the charge hose from the unit. Cover the valve ports of the refrigerant piping with caps and tighten them securely.
- Check for gas leakage applying a gas leak detector along the piping line.
- Start the air conditioner and make sure of its operating condition high side and low side pressures and temperature difference between suction air and outlet air.

6.3 Power supply remote operation

When the remote part on indoor unit PCB is modified, the air conditioner is turned ON-OFF by power supply ON-OFF operation without using remote control switch.

After the power supply remote operation, the operation contents can be modified by the remote controller.

(1) Operation contents

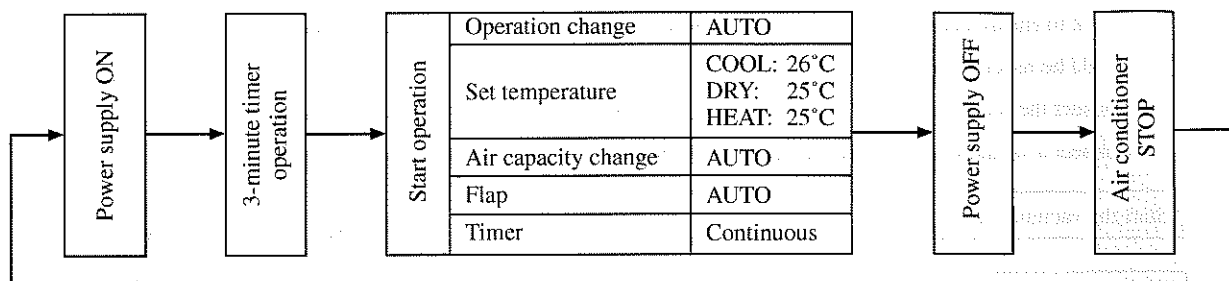

(2) Modification method

Solder the high-speed switching diode (manufacturer: Matsushita, Manufacture type No.: MA165) to "Remote" part on the PCB in the direction as shown in the diagram below.

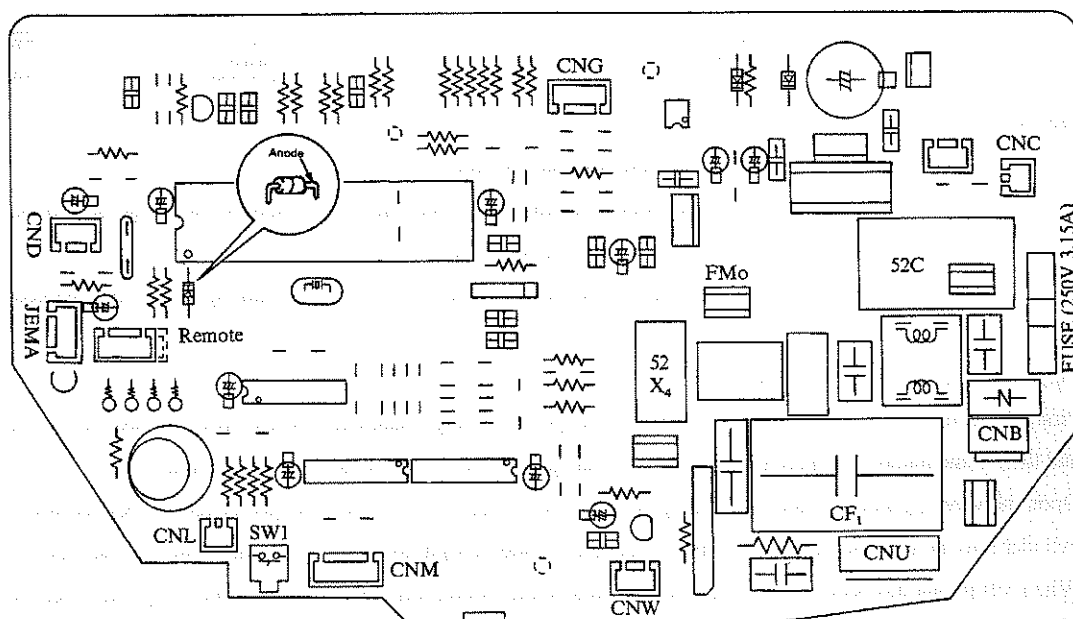

WALL MOUNTED TYPE ROOM AIR-CONDITIONER



Air-Conditioning & Refrigeration Systems Headquarters
16-5, 2-chome, Kounan, Minato-ku, Tokyo, 108-8215, Japan
Fax : (03) 6716-5926

No.036(1.1A)R



Большая библиотека технической документации
<https://splitsystema48.ru/instrukcii-po-ekspluatacii-kondicionerov.html>
каталоги, инструкции, сервисные мануалы, схемы.